



HADA Series

NETWORKABLE AMPLIFIERS
Digital Amplifiers



USER MANUAL

HW	SW	HADA DSP MANAGER & Updates	First Steps	Automatic Connection with PC	Login	Main Screen	Device Configuration	Admin Mode	Groups	TELNET Control
PRECAUTIONS	WARRANTY & ENVIRONMENT	PACKAGE CONTENTS	DESCRIPTION & FEATURES	PANEL FUNCTIONS	INSTALL & CONNECT	START-UP & OPERATION	TECHNICAL DATA			

TABLE OF CONTENTS

1. PRECAUTIONS	4
1.1 Important Notice.....	4
1.2 Key Safety Directions.....	5
1.3 Cleaning Directions.....	5
2. WARRANTY & ENVIRONMENT	6
3. PACKAGE CONTENTS	6
4. DESCRIPTION & FEATURES	7
4.1 Main Features.....	7
5. PANEL FUNCTIONS	8
5.1 Front Panel.....	8
5.2 Rear Panel	9
6. INSTALL & CONNECT	10
6.1 Location, Assembly and Ventilation.....	10
6.2 Mains Connection.....	11
6.3 Analogue Input Connections	12
6.4 Amplified Output Connections	13
6.4.1 Out Configurations	13
6.5 Remote Volume	14
6.5.1 Connecting the REMOTE VOL Control Ports.....	14
6.6 External Mute	14
6.7 Ethernet Ports	15
6.8 Reset.....	15
7. START-UP & OPERATION	16
7.1 Start-up.....	16
7.2 HADA DSP Manager Configuration.....	17
7.3 Bridge Mode and Hi-Z Mode.....	18
7.4 Recovery Mode.....	19
8. TECHNICAL DATA	20
8.1 Technical Specifications.....	20
8.1.1 HADA-4B150	20
8.1.2 HADA-4B250	23
8.1.3 HADA-4B400	26
8.1.4 HADA-4B500.....	29
8.1.5 HADA-4B750	32
8.2 Mechanical Diagrams.....	35



HW	Ctrl. SW
PRECAUTIONS	HADA DSP MANAGER & Updates
WARRANTY & ENVIRONMENT	First Steps
PACKAGE CONTENTS	Automatic Connection with PC
DESCRIPTION & FEATURES	Login
PANEL FUNCTIONS	Main Screen
INSTALL & CONNECT	Device Configuration
START-UP & OPERATION	Admin Mode
TECHNICAL DATA	Groups
	TELNET Control

8.2.1	HADA-4B150	35
8.2.2	HADA-4B250	36
8.2.3	HADA-4B400	37
8.2.4	HADA-4B500	38
8.2.5	HADA-4B750	39
9.	HADA DSP MANAGER	40
9.1	Updates	40
9.2	First Steps	40
9.3	Automatic Connection using a Computer	41
9.4	Login	42
9.5	Main Screen	43
9.5.1	File	44
9.5.2	Tools	44
9.5.3	Window	45
9.5.4	Help	46
9.6	Device Configuration	46
9.6.1	File	47
9.6.2	Edit	48
9.6.3	Window	49
9.6.4	Hardware	49
9.6.5	Help	50
9.6.6	Main	50
9.6.7	X-over	51
9.6.8	Inputs	52
9.6.9	Outputs	55
9.7	Admin Mode	58
9.7.1	Output Mode	59
9.7.2	Network Settings	61
9.7.3	Auto Standby	62
9.7.4	Boot-Up Mode	63
9.7.5	Change Access Rights for User level	64
9.7.6	Firmware Update	65
9.7.7	Create Flash Image	67
9.8	Groups	68
10.	TELNET CONTROL	70



HW	Ctrl. SW
PRECAUTIONS	HADA DSP MANAGER & Updates
WARRANTY & ENVIRONMENT	First Steps
PACKAGE CONTENTS	Automatic Connection with PC
DESCRIPTION & FEATURES	Login
PANEL FUNCTIONS	Main Screen
INSTALL & CONNECT	Device Configuration
START-UP & OPERATION	Admin Mode
TECHNICAL DATA	Groups
	TELNET Control

1. PRECAUTIONS

1.1 Important Notice



WARNING: SHOCK HAZARD - DO NOT OPEN

AVIS: RISQUE DE CHOC ÉLECTRIQUE - NE PAS OUVRIR



The flashing light with an arrowhead symbol inside an equilateral triangle on it is intended to alert the user of the presence of non-insulated “dangerous voltage” within the enclosure, which might be of sufficient magnitude to pose a risk of electric shock to users.



The exclamation mark within an equilateral triangle is intended to alert the user of the requirement for important operating and maintenance (servicing), for which instructions may be found in the literature accompanying the appliance.

WARNING (If applicable): The terminals marked with symbol “⚡” may be of sufficient magnitude to pose a risk of electric shock. The external wiring connected to terminals requires installation by a technician, or the use of ready-made leads or cords.

WARNING: To prevent fire or shock hazard, do not expose this equipment to rain or humidity.

WARNING: A device with Class I manufacturing ought to be connected to a mains socket outlet with a protective earthing connection.



WARNING: Ecler products have a long lifetime of more than 10 years. This product must never be discarded as unsorted urban waste, but must be taken to the nearest electrical and electronic waste treatment centre.



HW	Ctrl. SW	HADA DSP MANAGER & Updates	First Steps	Automatic Connection with PC	Login	Main Screen	Device Configuration	Admin Mode	Groups	TELNET Control
PRECAUTIONS	WARRANTY & ENVIRONMENT	PACKAGE CONTENTS	DESCRIPTION & FEATURES	PANEL FUNCTIONS	INSTALL & CONNECT	START-UP & OPERATION	TECHNICAL DATA			

1.2 Key Safety Directions

1. Read the following directions.
2. Keep the following directions.
3. Heed all warnings.
4. Follow all directions.
5. Do not use this device in proximity to water.
6. Clean only with a dry cloth.
7. Do not block any ventilation openings. Install in accordance with the manufacturer's instructions.
8. Do not install near any heat sources such as radiators, heat registers, stoves, or other devices (including amplifiers) that may release heat.
9. Do not defeat the safety purpose of the polarized or grounding type plug. A polarized plug has two blades, being one wider than the other. A grounding type plug has two blades and a third grounding prong. The wide blade or the third prong are provided for your safety. If the provided plug does not fit into your outlet, contact a qualified electrician for a replacement of the obsolete outlet.
10. Protect the power cord from being walked on or pinched, particularly at the plugs, convenience receptacles, and at the point of exit from the device.
11. Only use attachments/accessories specified by the manufacturer.
12. Unplug the device during lightening sorts or when unused for long periods of time.
13. Refer all servicing to qualified personnel. Servicing is required when the device has been damaged in any way, such as power supply cord or plug damage, liquid spillage or objects onto the device, the device has been exposed to rain or humidity, does not operate normally, or has been dropped.
14. Disconnecting from mains: When switching off the POWER switch, all the functions and light indicators of the unit will be stopped, but fully disconnecting the device from mains is done by unplugging the power cable from the mains input socket, therefore, it should always remain easily accessible
15. Equipment is connected to a socket-outlet with an earthing connection by means of a power cord.
16. The marking information is located at the bottom of the unit.
17. The device shall not be exposed to dripping or splashing liquids, and no liquid-filled objects, such as a filled up glass, shall be placed on top of the device.

1.3 Cleaning Directions



Clean the unit with a soft, dry clean cloth or slightly wet with water and neutral liquid soap only, then dry it with a clean cloth. Be careful that water never gets into the unit through any hole. Never use alcohol, benzine, solvents or abrasive substances to clean this unit.

NEEC AUDIO BARCELONA, S.L. accepts no liability for any damage that may be caused to people, animal, or objects due to failure to comply with the warnings above.



HW	Ctrl. SW	HADA DSP MANAGER & Updates	First Steps	Automatic Connection with PC	Login	Main Screen	Device Configuration	Admin Mode	Groups	TELNET Control	TECHNICAL DATA
----	----------	----------------------------	-------------	------------------------------	-------	-------------	----------------------	------------	--------	----------------	----------------

2. WARRANTY & ENVIRONMENT

**Thank you for choosing Ecler Hada Series!
We greatly value your trust.**

It is **VERY IMPORTANT** to carefully read this manual and to fully understand its contents before any connecting takes place in order to make the best use of this equipment, as well as to get the best performance from it.

To ensure optimal operation of this device, **we strongly recommend that its maintenance be carried out by our authorised Technical Services.**

All ECLER products are covered by warranty, please refer to www.ecler.com or the warranty card included with this product for the period of validity and conditions.



Ecler is truly committed with the environment and planet sustainability, energy saving and CO₂ emission reduction. Recycling materials and using non-contaminant components are also top priorities in our green crusade.

Ecler has deeply evaluated and analyzed the environmental impacts of all the processes involved in the production of this product, including packaging, and has alleviated, reduced and/or compensated for them.

3. PACKAGE CONTENTS

- 1 unit of one of the HADA Series models.
- EU mains cords.
- Euroblock Connectors (inputs /outputs)
- Desktop feet, rack 19" installation hardware.
- First Steps Guide.
- Warranty card.



HW	Ctrl. SW	HADA DSP MANAGER & Updates	First Steps	Automatic Connection with PC	Login	Main Screen	Device Configuration	Admin Mode	Groups	TELNET Control	TECHNICAL DATA
PRECAUTIONS	WARRANTY & ENVIRONMENT	PACKAGE CONTENTS	DESCRIPTION & FEATURES	PANEL FUNCTIONS	INSTALL & CONNECT	START-UP & OPERATION					

4. DESCRIPTION & FEATURES

HADA Series is a family of digital amplifiers, with different power levels: **HADA-4B150** with 125W, **HADA-4B250** with 250W, **HADA-4B400** with 400W, **HADA-4B500** with 500W and **HADA-4B750** with 750W.

All the models include 4 amplified channels that support Hi-Z and Low-Z loads down to 4 ohms.

A powerful DSP allows to manage the routing and the processing of the inputs and outputs through the [HADA DSP Manager Software](#). Routing functionality includes a matrix mixer for selecting which input channels to allocate to the outputs. Processing includes 10-band EQ, HP and LP filters, limiters, multi-band compressors, delay and factory and end-user configurable presets.

All models include a remote output volume control via the front potentiometers. It is also possible to connect external potentiometers in the rear panel, for the remote volume control of the outputs. Via an external contact, it is also possible to perform a general mute of the outputs, for emergency functions or integration purposes.

Another control option is network control via TCP/IP which allows to control the amplifier from third party control systems through customized user interfaces.

4.1 Main Features

- 4 amplified outputs in Lo-Z or 2 amplified outputs in Hi-Z.
- 4 balanced analogue inputs on Euroblock connectors.
- 4 GPI for remote volume control
- Internal matrix mixer and signal processing.
- HADA DSP Manager software for device configuration and control
- Third party TCP/IP control.



HW	Ctrl. SW	HADA DSP MANAGER & Updates	First Steps	Automatic Connection with PC	Login	Main Screen	Device Configuration	Admin Mode	Groups	TELNET Control	TECHNICAL DATA
PRECAUTIONS	WARRANTY & ENVIRONMENT	PACKAGE CONTENTS	DESCRIPTION & FEATURES	PANEL FUNCTIONS	INSTALL & CONNECT	START-UP & OPERATION					

5. PANEL FUNCTIONS

5.1 Front Panel

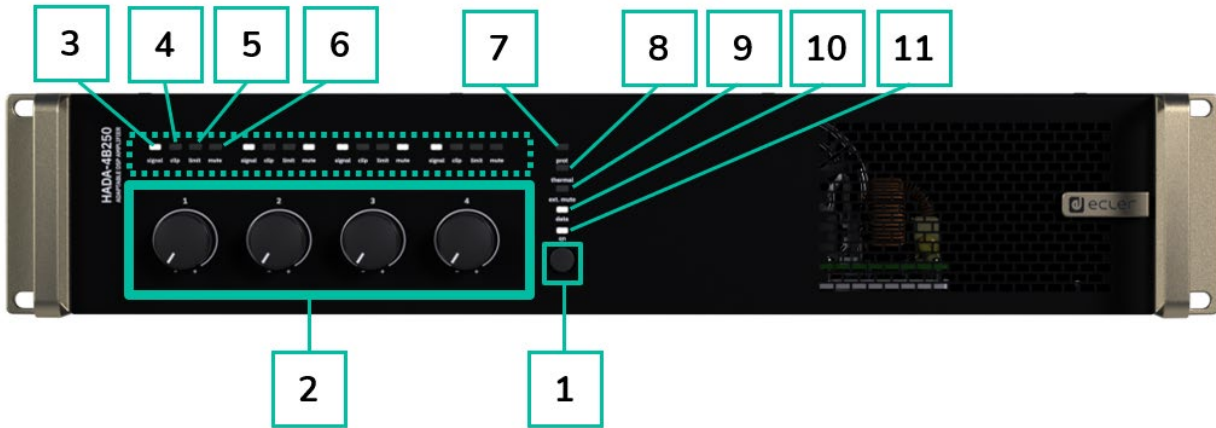

1. **ON/Standby Button:** the equipment is switched on by default just switching to ON the rear power switch.

- When the ON LED of the front panel is lit in white, the device is operational.
- To enter in standby mode, press and hold the ON button of the front panel until all LEDs on the front panel blink once. The prot. LED (red) will illuminate together with the ON LED (white) to indicate that standby mode is active.
- To exit standby mode, repeat the process.

2. **Control knobs (1-4):**

Each front panel LEVEL knob allows to control the correspondent amplified audio outputs. When two channels are bridged, potentiometer 1 or 3 will be the one taking control of the bridged channel pair, and 2 or 4 will be then inactive. [For further information see HADA DSP Manager chapter.](#)

💡 The **front panel knobs can be disabled** by holding down the ON button until all front panel LEDs flash three times. The same procedure will enable them again.

3. **Signal indicator LED:** indicates signal presence in the amplification output. These indicators light up in white colour when the input signal exceeds -36dBV threshold.

4. **Clip indicator LED:** lights up in red colour when the input signal exceeds +18dBV.

5. **Limit indicator LED:** lights up in red colour when the output signal reaches the limit set by software in the output limiter section. In case that any limiters are set, the LED lights up when the maximum power is reached.

💡 Depending by the **output mode configuration** (Dual or Bridge Mono) and the **output settings** (4 Ohm, 8 Ohm, 8 Ohm Bridge, 70V or 100V) **the behaviour of the limit LED changes**. Please ensure that the output configuration matches with the load in use.



HW	Ctrl. SW	HADA DSP MANAGER & Updates	First Steps	Automatic Connection with PC	Login	Main Screen	Device Configuration	Admin Mode	Groups	TELNET Control	TECHNICAL DATA
PRECAUTIONS	WARRANTY & ENVIRONMENT	PACKAGE CONTENTS	DESCRIPTION & FEATURES	PANEL FUNCTIONS	INSTALL & CONNECT	START-UP & OPERATION					

6. **Mute indicator LED:** lights up in white colour when the amplified output is muted.
7. **Prot. indicator LED:** lights up in red colour when any protection of the power module is active (along with the mute LEDs of the channels that are failing), or when the standby mode is active (along with the ON LED).
8. **Thermal indicator LED:** lights up in red colour when temperature limiter is activated.
9. **Ext. Mute LED:** lights up in white colour when the external mute is active.
10. **Data indicator LED:** lights up in white colour to indicate that the software HADA DSP Manager is online.
11. **On indicator LED:** in white colour indicates power energy activity.

5.2 Rear Panel

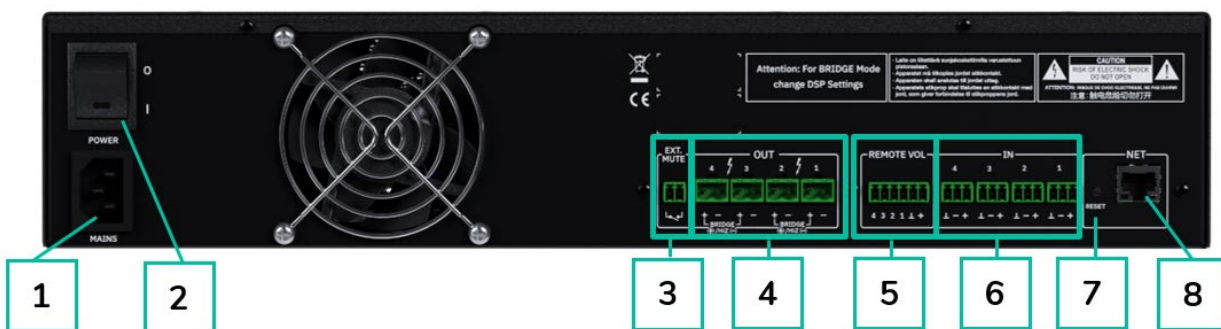

1. Mains socket base
2. Power switch
3. External mute port
4. Amplified outputs, OUT 1-4, 2-pin Euroblock
5. Remote Volume ports REMOTE 1-4, 6-pin Euroblock
6. Analogue inputs, IN 1-4, 3-pin Euroblock, balanced.
7. Reset button
8. RJ-45 ethernet network port, NET, RJ-45

6. INSTALL & CONNECT

The **equipment must be correctly grounded** (ground resistance, $R_g = 30 \text{ Ohm}$ or less). The environment must be dry and dustless. Do not expose the unit to rain or water splashes, and do not place liquid containers or incandescent objects like candles on top of the unit.

Do not obstruct the ventilation grilles with any kind of material. If the device requires any intervention and/or connection/disconnection, it must be first powered off.

Do not handle the speaker output terminals with your device turned on, there are high voltages. The output cabling should be connected by a qualified technician. Otherwise only use pre-made flexible cables. There are no user serviceable parts inside the amplifier.

! Non-compliance with the instructions or neglecting warnings may cause malfunction or even damage the unit.

- **Avoid turning on the device without the speakers connected to its outputs** and without having previously set the volume/gain controls to minimum level.
- **Always use shielded cables** to make connections between devices.
- **In an amplifier, avoid placing the speaker output cables close to other signal cables** (micro, line...). This may cause the system to oscillate, damaging the amplifier and speakers.

6.1 Location, Assembly and Ventilation

HADA series devices have a **19" rack format (2RU)**.

It is very important not to enclose the amplifier or expose it to extreme temperatures as it generates heat. It is also necessary to encourage the airflow through the ventilation holes of the chassis. The ventilation system forces the airflow, front to back, through the unit.

If multiple products are installed in the same rack or in a cabinet with closed doors, it is highly recommended to install fans in their upper and lower ends for a forced airflow from the bottom up. This upward air flow will help to dissipate the heat generated inside.

! It is advisable not to place power amplifiers under other appliances, but upon these ones. Hada amplifiers **can be stacked one on top of the other, leave one rack unit empty every 3 to guarantee an adequate heat sink.**

! Regular maintenance of dust removal is highly recommended as dust can impede airflow and hinder heat dissipation.



HW
Ctrl. SW

HADA DSP MANAGER &
Updates

PRECAUTIONS
WARRANTY &
ENVIRONMENT

First Steps
Automatic
Connection with PC

PACKAGE
CONTENTS

DESCRIPTION &
FEATURES

LogIn
Main Screen
PANEL FUNCTIONS

Device
Configuration
INSTALL & CONNECT

Admin Mode
Groups
START-UP & OPERATION

TECHNICAL DATA
TELNET Control

6.2 Mains Connection

HADA operates on alternating voltages from 90 to 264V and 47 to 63Hz. This device is equipped with an oversized power supply capable of adapting **without any type of adjustment to the mains voltage of any country in the world.**

On the **rear panel**, there is an **on/off switch** for the unit.



In the **front panel** there is the **button ON** with its LED indicator that **illuminates when the unit is in operation.**



To enter in standby mode, press and hold the ON button until all LEDs on the front panel blink once. The prot. LED (red) will illuminate together with the ON LED (white) to indicate that standby mode is active.

To exit standby mode, repeat the process.

Do not allow the mains cable to run parallel to the shielded cables carrying the audio signal, as this may cause humming.



Ctrl. SW

HADA DSP MANAGER & Updates

PRECAUTIONS

WARRANTY & ENVIRONMENT

First Steps

Automatic Connection with PC

PACKAGE CONTENTS

DESCRIPTION & FEATURES

Login

Main Screen

PANEL FUNCTIONS

Device Configuration

INSTALL & CONNECT

Admin Mode

Groups

START-UP & OPERATION

TELNET Control

TECHNICAL DATA

6.3 Analogue Input Connections

HADA rear panel provides analogue, balanced, line level signal inputs. The selection of hardware inputs and their routing and mixing towards either amplifier channel is performed from its embedded web application. [For further information, please refer to HADA DSP Manager chapter.](#)



Signal input connectors are 3 position screw terminal block. The wiring is:

- | | | | |
|-------------------------|---|-----|---|
| Live or direct signal | > | Pin | + |
| Cold or inverted signal | > | Pin | - |
| Ground | > | Pin | ⊥ |

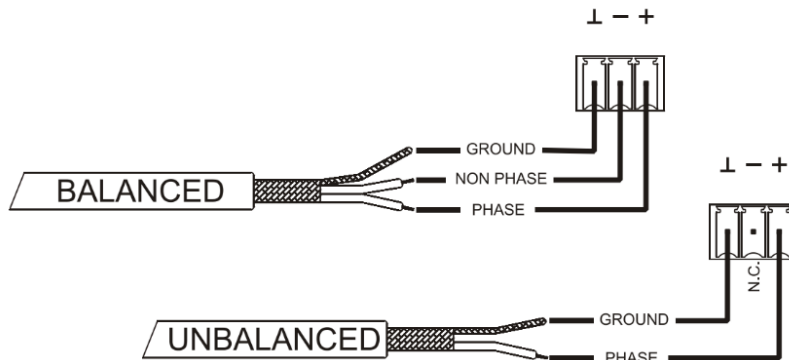

For **unbalanced connection** short-circuit pin ⊥ to pin - as reported on the picture.

HW	Ctrl. SW	HADA DSP MANAGER & Updates	First Steps	Automatic Connection with PC	Login	Main Screen	Device Configuration	Admin Mode	Groups	TELNET Control	TECHNICAL DATA
PRECAUTIONS	WARRANTY & ENVIRONMENT	PACKAGE CONTENTS	DESCRIPTION & FEATURES	PANEL FUNCTIONS	INSTALL & CONNECT	START-UP & OPERATION					

6.4 Amplified Output Connections

The rear panel is fitted with **two position screw terminal block for each amplified output.**



! Always respect the relative polarity for outputs (+ and - on each output connector), wiring and speakers.

6.4.1 Out Configurations

[HADA DSP Manager software](#) allows to configure the amplifier to operate in high impedance/bridge mode, or low impedance.

! Select the appropriate operation mode to do not damage the loudspeakers. **Never connect loads below 4 ohms when working in low impedance mode.**

! HiZ and Bridge modes must use the first or the second pair of channels. Please connect the loudspeakers as reported on the silkscreens when HiZ mode or Bridge mode is required.

! Make sure to match the impedance of the total load connected to the loudspeakers, when working in low impedance for a correct performance. If impedance values do not match, select the closer one above.

6.4.1.1 Operation Example

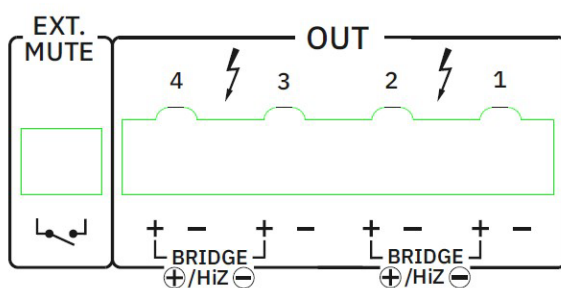

AMP OUT1-2: HiZ-100V

! When OUT 1-2 are configured in bridge, use **both + pins** to connect the loudspeakers. The + on the left is the positive.

AMP OUT3: LoZ-8ohm

AMP OUT4: LoZ-4ohm

! When LoZ is selected the channels operate **independently** with declared maximum power.

! The connection cable that joins the amplifiers outputs and the loudspeakers must be of good quality, sufficient section and as short as possible. This is most important when the distances to cover are long ones i.e., up to 10 meters it is recommended to use a section not inferior to 2.5mm² and for superior distances 4mm².



HW
Ctrl.
SW

HADA DSP MANAGER &
Updates

PRECAUTIONS
WARRANTY &
ENVIRONMENT

First Steps

Automatic
Connection with PC

DESCRIPTION &
FEATURES

Login

Main Screen

PANEL FUNCTIONS

Device
Configuration

Admin Mode

Groups

START-UP & OPERATION

TELNET Control

TECHNICAL DATA

6.5 Remote Volume

HADA rear panel provides four remote control ports, labelled "REMOTE VOL 1-4", to which you can connect analogue devices such as the WPa series wall panels or common 10 Kohm linear potentiometers. These ports **allow to control the volume of the output channels**: each REMOTE VOL input is associated with its own corresponding output channel.



When GPIs are used in combination with front potentiometers, the potentiometer set at the lower value between the two, is the one that defines the maximum output level.

6.5.1 Connecting the REMOTE VOL Control Ports

The **REMOTE VOL** connectors are **Euroblock type**. The assignment of the connection is as follows:

Positive, + 3.3 VDC	>	Pin	+
Variable voltage, 0-3.3 VDC	>	Pin	1-4
Ground	>	Pin	⊥

The connection cables can be up to 500m long if a section of 0.5mm² is used.

6.6 External Mute

HADA has on its rear panel a control input, or **EXT. MUTE** port which allows the activation / deactivation of the mute of audio outputs (zones) of the unit by means of a push button, relay, or external potential free contact closure.



The EXT. MUTE works as normally open contact.



HW
Ctrl. SW

HADA DSP MANAGER & Updates

PRECAUTIONS
WARRANTY & ENVIRONMENT

First Steps

Automatic Connection with PC

DESCRIPTION & FEATURES

Login

Main Screen

PANEL FUNCTIONS

Device Configuration

Admin Mode

Groups

TELNET Control

INSTALL & CONNECT

START-UP & OPERATION

TECHNICAL DATA

6.7 Ethernet Ports

The RJ-45-type ETHERNET connector on the rear panel, named NET, allows the equipment to be connected to an Ethernet network, or directly to a computer or other device with an Ethernet interface, point-to-point.



This connection enables, within a local network, the following:

- Global programming and management of the HADA units using Windows® [software HADA DSP Manager](#).
- Connection of third-party devices for integration in control systems (Crestron®, Extron®, AMX®, Vity®, Medialon®, etc., registered trademarks by their manufacturers), using the Third Party TCP/IP control embedded in HADA devices. [Refer to the Telnet Control chapter for more information](#).

6.8 Reset

The RESET button on the rear panel, allows to restore the network settings.



In case you have set a fixed network address and have forgotten it, holding down the reset button for more than 10 seconds will allow you to set the network interface to DHCP mode as from the factory. In this way, using the HADA DSP Manager software in a PC with its network card set as a DHCP client, it will be possible to perform amplifier discovery and change the network settings again.



A factory default of the DSP parameters can be performed by [uploading a factory default preset through HADA DSP Manager](#).



HW	Ctrl. SW	HADA DSP MANAGER & Updates	First Steps	Automatic Connection with PC	Login	Main Screen	Device Configuration	Admin Mode	Groups	TELNET Control	TECHNICAL DATA
PRECAUTIONS	WARRANTY & ENVIRONMENT	PACKAGE CONTENTS	DESCRIPTION & FEATURES	PANEL FUNCTIONS	INSTALL & CONNECT	START-UP & OPERATION					

7. START-UP & OPERATION

7.1 Start-up

When the rear panel Power switch is ON, the amplifier is powered, and it will automatically switch on.



When the ON LED of the front panel is lit in white, the device is operational.

To enter in standby mode, press and hold the ON button until all LEDs on the front panel blink once. The prot. LED (red) will illuminate together with the ON LED (white) to indicate that standby mode is active.

To exit standby mode, repeat the process.

In a complete audio installation, it is important to start up the equipment in the following sequence:

1. sound sources
2. mixer
3. equalizers
4. active filters
5. processors
6. power amplifiers.

To turn them off the sequence should follow an inverse pattern.



HW
Ctrl.
SW

HADA DSP MANAGER &
Updates

PRECAUTIONS
WARRANTY &
ENVIRONMENT

First Steps
Automatic
Connection with PC

PACKAGE
CONTENTS

DESCRIPTION &
FEATURES

Login
Main Screen

PANEL FUNCTIONS
Device
Configuration

INSTALL & CONNECT
Admin Mode
Groups
TELNET Control

TECHNICAL DATA

7.2 HADA DSP Manager Configuration

Once the physical connections have been made, the HADA units must be configured using the [HADA DSP Manager software](#).

The HADA network interface comes from the factory in DHCP client mode. This means that if a DHCP server is present in the network, it will automatically provide the IP address to the device. In the absence of a DHCP server, as in standard networks, the HADA network interface will take a random address in the 169.254.x.y class.

If your PC's network card is also configured in DHCP mode, **through the automatic discovery of the HADA DSP Manager software you can easily find all your networked amplifiers** which will appear as a list in the main software window.

Once the list of amplifiers in the network is ready, you can click on the arrow to the right of each one to open the configuration window.

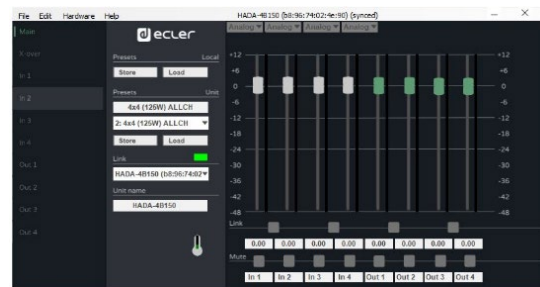
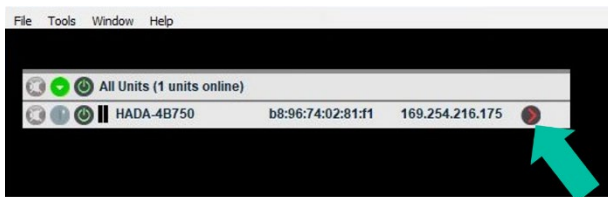

In case your HADA amplifier cannot be found by the software, please reset the unit. [For further details see chapter Reset.](#)

[Please refer to HADA DSP Manager chapter](#) for information about parameters, settings and available features.



HW
Ctrl.
SW

HADA DSP MANAGER &
Updates

PRECAUTIONS
WARRANTY &
ENVIRONMENT

First Steps
Automatic
Connection with PC

PACKAGE
CONTENTS

DESCRIPTION &
FEATURES

Login
Main Screen

PANEL FUNCTIONS
Device
Configuration

INSTALL & CONNECT
Admin Mode
Groups
TELNET Control
TECHNICAL DATA

7.3 Bridge Mode and Hi-Z Mode

Bridge or HiZ mode, which allows 100V/70V line loudspeakers to be connected, must be set via the [HADA DSP Manager](#).

Please configure the correct output mode via software before connecting the loudspeakers line:

- **Dual:** Each channel work as a single channel in low impedance mode.
- **Bridge Mono:** Two channels are coupled in bridge for high impedance lines of loudspeakers.

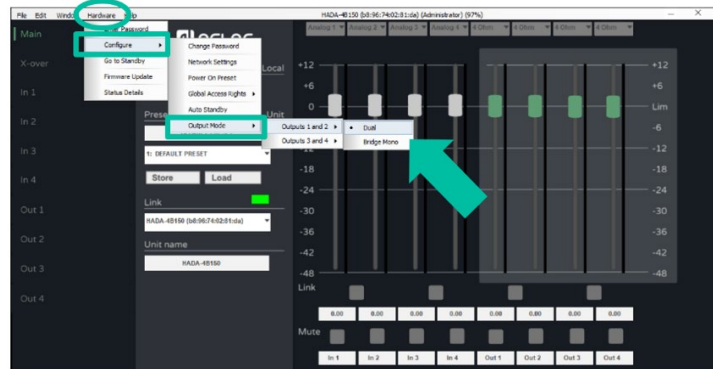

Once the Bridge Mono mode is set, connect the loudspeakers line at 100V or 70V as indicated below:

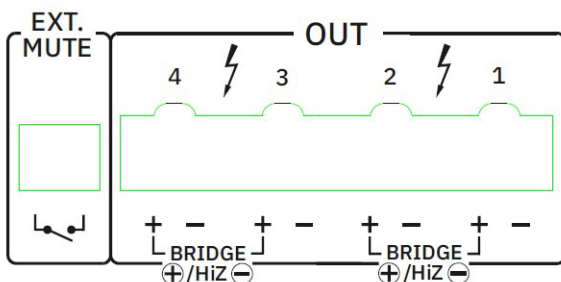

- The Positive pin **+** of the output in bridge mode is the left one.
- When channel 1 and 2 are set as bridge, the input connector to use is the Input 1 and the volume control is the one of channel 1.
- When channel 3 and 4 are set as bridge, the input connector to use is the Input 3 and the volume control is the one of channel 3.

After selecting the desired output mode, please remember to set the right load on each output. These settings will allow the amplifier's internal parameters to be adapted to work optimally with different types of load.

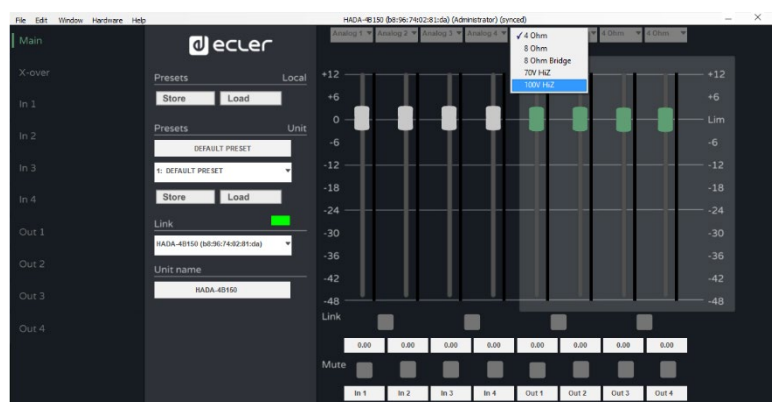

The selection of the load type for each output is available only by logging into HADA DSP Manager with administrator credentials.



HW	Ctrl. SW
PRECAUTIONS	HADA DSP MANAGER & Updates
WARRANTY & ENVIRONMENT	First Steps
PACKAGE CONTENTS	Automatic Connection with PC
DESCRIPTION & FEATURES	Login
PANEL FUNCTIONS	Main Screen
INSTALL & CONNECT	Device Configuration
START-UP & OPERATION	Admin Mode
TECHNICAL DATA	Groups
	TELNET Control

7.4 Recovery Mode

In case that a firmware issue appears, or a firmware update fails, the HADA unit will automatically load an emergency firmware called “Recovery Mode”.

This allows to connect with Ecler HADA DSP Manager and update the firmware again with the correct firmware of each HADA model.

When the unit is in this special state, all the front LEDs of the unit (Prot., Thermal, Ext. Mute, Data and ON) will blink at the same time. Audio signal will be processed by the DSP and a special limitation of all the outputs will avoid damaging the amplifier modules.

 **To exit from recovery mode**, please enter the administrator credentials and update the firmware of the unit.

 **Each HADA unit needs to be updated with the right firmware related to each model.**



HW	Ctrl. SW	HADA DSP MANAGER & Updates	First Steps	Automatic Connection with PC	Login	Main Screen	Device Configuration	Admin Mode	Groups	TELNET Control	TECHNICAL DATA
PRECAUTIONS	WARRANTY & ENVIRONMENT	PACKAGE CONTENTS	DESCRIPTION & FEATURES	PANEL FUNCTIONS	INSTALL & CONNECT	START-UP & OPERATION					

8. TECHNICAL DATA

8.1 Technical Specifications

8.1.1 HADA-4B150

HADA-4B150

INPUTS	
Number of Inputs	4 analogue input channels
Analogue input connection type	IN1-4: 3-pin Euroblock, balanced, pitch 3,5 mm.
Input configuration	Digital matrix 4 in x 4 amp. out (Settings by HADA DSP Manager)
AMPLIFIED OUTPUTS	
Number of amplified outputs	4
Amplified output connection type	2-pin Euroblock.
Output configuration	Lo-Z/Hi-Z, 70V/100V, 4Ω/8Ω Output mode selection per channel/couple by software (Settings by HADA DSP Manager)
OUTPUT POWER (all channels driven @ 1%THD)	
Max output power @ 8Ω	125W
Max output power @ 4Ω	125W
Max output power @ 8Ω bridge mode	250W
Max output power @ 100V	250W (Bridge Mode)
Max output power @ 70V	250W (Bridge Mode)
SIGNAL	
Voltage gain	27 to 37 dBV 29,2 to 39,2 dBu
Input sensitivity	-12 to 12 dBV -9,8 to 14,2 dBu 0,25 to 3,98 Vrms @ Nominal power
Input impedance	21k (balanced)
Max input level	22 dBV 24,2 dBu
Frequency response	20Hz-20kHz (-3dB, 1W any load)
THD + Noise	< 0,01 0.015 Typ (@ 1kHz, from 0,1W to Full Power)
Crosstalk	>60dB (@ 1kHz)
ELECTRICAL	
Power supply	Universal, SMPS with PFC
AC mains requirement	100-240 V @ 50-60Hz (±10%)
Power factor correction	> 0,92
AC mains connector	IEC C14 inlet
POWER CONSUMPTION @230VAC	
Power Consumption (1/4 POWER, @ 4Ω)	277W (all channels driven)
Power Consumption (1/8 POWER, @ 4Ω)	145W (all channels driven)
Power Consumption (IDLE)	14.5W
Power Consumption (STBY)	8.5W



HW	Ctrl. SW
PRECAUTIONS	HADA DSP MANAGER & Updates
WARRANTY & ENVIRONMENT	First Steps
PACKAGE CONTENTS	Automatic Connection with PC
DESCRIPTION & FEATURES	Login
PANEL FUNCTIONS	Main Screen
INSTALL & CONNECT	Device Configuration
START-UP & OPERATION	Admin Mode
TECHNICAL DATA	Groups
	TELNET Control

TECHNOLOGIES	
Amplification technology	Class D
Cooling	Fan (Forced air, front to back airflow. Temperature controlled continuously variable speed)
Maximum fan noise	46 dB (Maximum acoustical noise @1m)
PROTECTIONS	
DC protection	Yes (Protects loudspeaker and installation against DC and infrasonic signals at the outputs)
HF protection	Yes (Protects the loudspeakers against non-audible, strong, non-musical high frequency signals)
Short-circuit protection	Yes (Protects the amplifier from overcurrent, short circuit or other stressful events for the output stages with output reduction or MUTE (automatic protection reset))
Thermal protection	Yes (Output power reduction when output stages operating temperature up to 90 °C (194 °F) Mute when output stages operating temperature up to 100 °C (212 °F))
REMOTE CONTROL CONNECTIONS	
ON / OFF	No
GPIs	x4 GPIs (0-3.3V) (5-pin Euroblock connector, rear panel)
External MUTE	Yes, dry contact (2 pins Euroblock connector, rear panel. Euroblock pitch 3,5 mm)
LOCAL CONTROL	
Attenuators	Front panel knobs (Defaults: Amplified OUTs attenuators)
Output mode settings	Lo-Z/Hi-Z, 70V/100V, 4Ω/8Ω Output mode selection per couple of channels (Software)
RUN/SLEEP mode	Yes, front panel push-button (Operates when pressed more than 3 seconds)
Power ON/OFF	Yes, back panel switch (Red LED indicator)
CONNECTIVITY	
Ethernet	Ethernet Base-Tx 100Mb (CAT5 up to 100m. Settings by embedded web application)
Programming and control	HADA DSP Manager Application
MONITORING	
Signal Present	SP LED (White) per channel (trigger @- 40 dBV)
Clipping	CLIP LED (Red) per channel
Limit	LIMIT LED (Red) per channel
Mute	MUTE LED (White) per channel
Prot.	PROT. LED (Red) per unit
Thermal	THERMAL LED (Red) per unit (Temperature limiter)
Ext. Mute	Ext. MUTE LED (White) per unit (OFF NO WIRE, ON when MASTER, BLINK when SLAVE)
Data	DATA LED (White) per unit (ON when DATA)
On	ON LED (White) per unit (ON when RUN, SLOW BLINK when SLEEP by BUTTON, FAST BLINK when SLEEP by AUTOSTBY, VERY FAST BLINK when HW Fault)
DIGITAL ENGINE	
Processor	Dual core 64bits



HW
Ctrl.
SW

PRECAUTIONS
HADA DSP MANAGER &
Updates

WARRANTY &
ENVIRONMENT
First Steps

PACKAGE
CONTENTS
Automatic
Connection with PC

DESCRIPTION &
FEATURES
Login

PANEL FUNCTIONS
Main Screen

INSTALL & CONNECT
Device
Configuration

START-UP & OPERATION
Admin Mode

TECHNICAL DATA
Groups

TECHNICAL DATA
TELNET Control

TECHNICAL DATA

AUDIO CONVERTERS	
Sampling rate	96 kHz
Resolution	24 bit
Dynamic range	113 dB
PROCESSING	
Digital processing	64 bit
Latency	500uS (Analogue IN to analogue OUT)
Inputs processing	Delay, Parametric EQ, Limiter, Multiband compressor (Settings via HADA DSP Manager)
Outputs processing	Delay, Parametric EQ, Limiter, Multiband compressor (Settings via HADA DSP Manager)
Others	Preset management, 4x4 Matrix Mixer (Settings via HADA DSP Manager)
PHYSICAL	
Operating temperature	Min. 0°C; 32°F Max. 40°C; 104°F (performance may be reduced above 40°C)
Operating humidity	5 - 80% RH, non-condensing
Storage temperature	Min. -10°C; 14°F Max. 50°C; 122°F
Storage humidity	5 - 85% RH, non-condensing
Installation options	Rack 19" installation & desktop
Included accessories	EU Main cord, Euroblock Connectors (inputs /outputs), Desktop feet, rack 19" installation hardware.
Optional accessories	-
Dimensions (WxHxD)	482.6 x 88 x 281,5 mm / 19 x 3.46 x 11.08 in.
Weight	4.7 Kg / 10.36 lb
Shipping dimensions (WxHxD)	495 x 125 x 560 mm. / 19.48 x 4.92 x 22.05 in.
Shipping weight	6,8 kg / 14.9 lb



HW	Ctrl. SW	HADA DSP MANAGER & Updates	First Steps	Automatic Connection with PC	Login	Main Screen	Device Configuration	Admin Mode	Groups	TELNET Control	TECHNICAL DATA
PRECAUTIONS	WARRANTY & ENVIRONMENT	PACKAGE CONTENTS	DESCRIPTION & FEATURES	PANEL FUNCTIONS	INSTALL & CONNECT	START-UP & OPERATION					

8.1.2 HADA-4B250

HADA-4B250

INPUTS	
Number of Inputs	4 analogue input channels
Analogue input connection type	IN1-4: 3-pin Euroblock, balanced, pitch 3,5 mm.
Input configuration	Digital matrix 4 in x 4 amp. out (Settings by HADA DSP Manager)
AMPLIFIED OUTPUTS	
Number of amplified outputs	4
Amplified output connection type	2-pin Euroblock.
Output configuration	Lo-Z/Hi-Z, 70V/100V, 4Ω/8Ω Output mode selection per channel/couple by software (Settings by HADA DSP Manager)
OUTPUT POWER (all channels driven @ 1%THD)	
Max output power @ 8Ω	250W
Max output power @ 4Ω	250W
Max output power @ 8Ω bridge mode	500W
Max output power @ 100V	500W (Bridge Mode)
Max output power @ 70V	500W (Bridge Mode)
SIGNAL	
Voltage gain	30 to 37 dBV 32,2 to 39,2 dBu
Input sensitivity	-12 to 12 dBV -9,8 to 14,2 dBu 0,25 to 3,98 Vrms @ Nominal power
Input impedance	21k (balanced)
Max input level	22 dBV 24,2 dBu
Frequency response	20Hz-20kHz (-3dB, 1W any load)
THD + Noise	< 0,01 0.015 Typ (@ 1kHz, from 0,1W to Full Power)
Crosstalk	>80dB (@ 1kHz)
ELECTRICAL	
Power supply	Universal, SMPS with PFC
AC mains requirement	100-240 V @ 50-60Hz (±10%)
Power factor correction	> 0,92
AC mains connector	IEC C14 inlet
POWER CONSUMPTION @230VAC	
Power Consumption (1/4 POWER, @ 4Ω)	428W (all channels driven)
Power Consumption (1/8 POWER, @ 4Ω)	235W (all channels driven)
Power Consumption (IDLE)	19W
Power Consumption (STBY)	13W
TECHNOLOGIES	
Amplification technology	Class D
Cooling	Fan (Forced air, front to back airflow. Temperature controlled continuously variable speed)
Maximum fan noise	40 dB (Maximum acoustical noise @1m)



HW
Ctrl.
SW

PRECAUTIONS
HADA DSP MANAGER &
Updates

WARRANTY &
ENVIRONMENT
First Steps

PACKAGE
CONTENTS
Automatic
Connection with PC

DESCRIPTION &
FEATURES
Login

PANEL FUNCTIONS
Main Screen

INSTALL & CONNECT
Device
Configuration

START-UP & OPERATION
Admin Mode

TECHNICAL DATA
Groups

TECHNICAL DATA
TELNET Control

TECHNICAL DATA

PROTECTIONS		
DC protection	Yes (Protects loudspeaker and installation against DC and infrasonic signals at the outputs)	
HF protection	Yes (Protects the loudspeakers against non-audible, strong, non-musical high frequency signals)	
Short-circuit protection	Yes (Protects the amplifier from overcurrent, short circuit or other stressful events for the output stages with output reduction or MUTE (automatic protection reset))	
Thermal protection	Yes (Output power reduction when output stages operating temperature up to 90 °C (194 °F) Mute when output stages operating temperature up to 100 °C (212 °F))	
REMOTE CONTROL CONNECTIONS		
ON / OFF	No	
GPIs	x4 GPIs (0-3.3V) (5-pin Euroblock connector, rear panel)	
External MUTE	Yes, dry contact (2 pins Euroblock connector, rear panel. Euroblock pitch 3,5 mm)	
LOCAL CONTROL		
Attenuators	Front panel knobs (Defaults: Amplified OUTs attenuators)	
Output mode settings	Lo-Z/Hi-Z, 70V/100V, 4Ω/8Ω Output mode selection per couple of channels (Software)	
RUN/SLEEP mode	Yes, front panel push-button (Operates when pressed more than 3 seconds)	
Power ON/OFF	Yes, back panel switch (Red LED indicator)	
CONNECTIVITY		
Ethernet	Ethernet Base-Tx 100Mb (CAT5 up to 100m. Settings by embedded web application)	
Programming and control	HADA DSP Manager Application	
MONITORING		
Signal Present	SP LED (White) per channel (trigger @- 40 dBV)	
Clipping	CLIP LED (Red) per channel	
Limit	LIMIT LED (Red) per channel	
Mute	MUTE LED (White) per channel	
Prot.	PROT. LED (Red) per unit	
Thermal	THERMAL LED (Red) per unit (Temperature limiter)	
Ext. Mute	ext. MUTE LED (White) per unit (OFF NO WIRE, ON when MASTER, BLINK when SLAVE)	
Data	DATA LED (White) per unit (ON when DATA)	
On	ON LED (White) per unit (ON when RUN, SLOW BLINK when SLEEP by BUTTON, FAST BLINK when SLEEP by AUTOSTBY, VERY FAST BLINK when HW Fault)	
DIGITAL ENGINE		
Processor	Dual core 64bits	
AUDIO CONVERTERS		
Sampling rate	96 kHz	
Resolution	24 bit	
Dynamic range	113 dB	



HW Ctr. SW

PRECAUTIONS HADA DSP MANAGER & Updates

WARRANTY & ENVIRONMENT First Steps

PACKAGE CONTENTS Automatic Connection with PC

DESCRIPTION & FEATURES Login

PANEL FUNCTIONS Main Screen

INSTALL & CONNECT Admin Mode

START-UP & OPERATION Groups

TECHNICAL DATA TELNET Control

TECHNICAL DATA

TECHNICAL DATA

TECHNICAL DATA

PROCESSING	
Digital processing	64 bit
Latency	500uS (Analogue IN to analogue OUT)
Inputs processing	Delay, Parametric EQ, Limiter, Multiband compressor (Settings via HADA DSP Manager)
Outputs processing	Delay, Parametric EQ, Limiter, Multiband compressor (Settings via HADA DSP Manager)
Others	Preset management, 4x4 Matrix Mixer (Settings via HADA DSP Manager)
PHYSICAL	
Operating temperature	Min. 0°C; 32°F Max. 40°C; 104°F (performance may be reduced above 40°C)
Operating humidity	5 - 85% RH, non-condensing
Storage temperature	Min. -10°C; 14°F Max. 50°C; 122°F
Storage humidity	5 - 80% RH, non-condensing
Installation options	Rack 19" installation & desktop
Included accessories	EU Main cord, Euroblock Connectors (inputs /outputs), Desktop feet, rack 19" installation hardware
Optional accessories	-
Dimensions (WxHxD)	482.6 x 88 x 281,5 mm / 19 x 3.46 x 11.08 in.
Weight	5.0 Kg / 11.02 lb
Shipping dimensions (WxHxD)	495 x 125 x 560 mm. / 19.48 x 4.92 x 22.05 in.
Shipping weight	6,8 kg / 14.9 lb



HW Ctr. SW

PRECAUTIONS HADA DSP MANAGER & Updates

WARRANTY & ENVIRONMENT First Steps

PACKAGE CONTENTS Automatic Connection with PC

DESCRIPTION & FEATURES Login

PANEL FUNCTIONS Main Screen

INSTALL & CONNECT Device Configuration

START-UP & OPERATION Admin Mode

TECHNICAL DATA Groups

TECHNICAL DATA TELNET Control

TECHNICAL DATA

8.1.3 HADA-4B400

HADA-4B400

INPUTS		
Number of Inputs	4 analogue input channels	
Analogue input connection type	IN1-4: 3-pin Euroblock, balanced, pitch 3,5 mm.	
Input configuration	Digital matrix 4 in x 4 amp. out (Settings by HADA DSP Manager)	
AMPLIFIED OUTPUTS		
Number of amplified outputs	4	
Amplified output connection type	2-pin Euroblock.	
Output configuration	Lo-Z/Hi-Z, 70V/100V, 4Ω/8Ω Output mode selection per channel/couple by software (Settings by HADA DSP Manager)	
OUTPUT POWER (all channels driven @ 1%THD)		
Max output power @ 8Ω	400W	
Max output power @ 4Ω	400W	
Max output power @ 8Ω bridge mode	800W	
Max output power @ 100V	800W (Bridge mode)	
Max output power @ 70V	800W (Bridge Mode)	
SIGNAL		
Voltage gain	31 to 38 dBV 33,2 to 40,2 dBu	
Input sensitivity	-12 to 12 dBV -9,8 to 14,2 dBu 0,25 to 3,98 Vrms @ Nominal power	
Input impedance	21k (balanced)	
Max input level	22 dBV 24,2 dBu	
Frequency response	20Hz-20kHz (-3dB, 1W any load)	
THD + Noise	< 0,01 0.015 Typ (@ 1kHz, from 0,1W to Full Power)	
Crosstalk	>80dB (@ 1kHz)	
ELECTRICAL		
Power supply	Universal, SMPS with PFC	
AC mains requirement	100-240 V @ 50-60Hz (±10%)	
Power factor correction	> 0,96	
AC mains connector	IEC C14 inlet	
POWER CONSUMPTION @230VAC		
Power Consumption (1/4 POWER, @ 4Ω)	621W (all channels driven)	
Power Consumption (1/8 POWER, @ 4Ω)	345W (all channels driven)	
Power Consumption (IDLE)	20W	
Power Consumption (STBY)	9W	
TECHNOLOGIES		
Amplification technology	Class D	
Cooling	Fan (Forced air, front to back airflow. Temperature controlled continuously variable speed)	
Maximum fan noise	40 dB (Maximum acoustical noise @1m)	



HW
Ctrl.
SW

PRECAUTIONS
HADA DSP MANAGER &
Updates

WARRANTY &
ENVIRONMENT
First Steps

PACKAGE
CONTENTS
Automatic
Connection with PC

DESCRIPTION &
FEATURES
Login

PANEL FUNCTIONS
Main Screen

INSTALL & CONNECT
Device
Configuration

START-UP & OPERATION
Admin Mode
Groups

TECHNICAL DATA
TELNET Control

PROTECTIONS		
DC protection	Yes (Protects loudspeaker and installation against DC and infrasonic signals at the outputs)	
HF protection	Yes (Protects the loudspeakers against non-audible, strong, non-musical high frequency signals)	
Short-circuit protection	Yes (Protects the amplifier from overcurrent, short circuit or other stressful events for the output stages with output reduction or MUTE (automatic protection reset))	
Thermal protection	Yes (Output power reduction when output stages operating temperature up to 90 °C (194 °F) Mute when output stages operating temperature up to 100 °C (212 °F))	
REMOTE CONTROL CONNECTIONS		
ON / OFF	No	
GPIs	x4 GPIs (0-3.3V) (5-pin Euroblock connector, rear panel)	
External MUTE	Yes, dry contact (2 pins Euroblock connector, rear panel. Euroblock pitch 3,5 mm)	
LOCAL CONTROL		
Attenuators	Front panel knobs (Defaults: Amplified OUTs attenuators)	
Output mode settings	Lo-Z/Hi-Z, 70V/100V, 4Ω/8Ω Output mode selection per couple of channels (Software)	
RUN/SLEEP mode	Yes, front panel push-button (Operates when pressed more than 3 seconds)	
Power ON/OFF	Yes, back panel switch (Red LED indicator)	
CONNECTIVITY		
Ethernet	Ethernet Base-Tx 100Mb (CAT5 up to 100m. Settings by embedded web application)	
Programming and control	HADA DSP Manager Application	
MONITORING		
Signal Present	SP LED (White) per channel (trigger @- 40 dBV)	
Clipping	CLIP LED (Red) per channel	
Limit	LIMIT LED (Red) per channel	
Mute	MUTE LED (White) per channel	
Prot.	PROT. LED (Red) per unit	
Thermal	THERMAL LED (Red) per unit (Temperature limiter)	
Ext. Mute	ext. MUTE LED (White) per unit (OFF NO WIRE, ON when MASTER, BLINK when SLAVE)	
Data	DATA LED (White) per unit (ON when DATA)	
On	ON LED (White) per unit (ON when RUN, SLOW BLINK when SLEEP by BUTTON, FAST BLINK when SLEEP by AUTOSTBY, VERY FAST BLINK when HW Fault)	
DIGITAL ENGINE		
Processor	Dual core 64bits	
AUDIO CONVERTERS		
Sampling rate	96 kHz	
Resolution	24 bit	
Dynamic range	113 dB	



HW SW

HADA DSP MANAGER & Updates

PRECAUTIONS

WARRANTY & ENVIRONMENT

PACKAGE CONTENTS

DESCRIPTION & FEATURES

Automatic Connection with PC

Login

Main Screen

PANEL FUNCTIONS

Device Configuration

Admin Mode

Groups

START-UP & OPERATION

TECHNICAL DATA

TELNET Control

PROCESSING	
Digital processing	64 bit
Latency	500uS (Analogue IN to analogue OUT)
Inputs processing	Delay, Parametric EQ, Limiter, Multiband compressor (Settings via HADA DSP Manager)
Outputs processing	Delay, Parametric EQ, Limiter, Multiband compressor (Settings via HADA DSP Manager)
Others	Preset management, 4x4 Matrix Mixer (Settings via HADA DSP Manager)
PHYSICAL	
Operating temperature	Min. 0°C; 32°F Max. 40°C; 104°F (performance may be reduced above 40°C)
Operating humidity	5 - 80% RH, non-condensing
Storage temperature	Min. -10°C; 14°F Max. 50°C; 122°F
Storage humidity	5 - 85% RH, non-condensing
Installation options	Rack 19" installation & desktop
Included accessories	EU Main cord, Euroblock Connectors (inputs /outputs), Desktop feet, rack 19" installation hardware
Optional accessories	-
Dimensions (WxHxD)	482.6 x 88 x 281,5 mm / 19 x 3.46 x 11.08 in.
Weight	5.4 Kg / 11.91 lb
Shipping dimensions (WxHxD)	495 x 125 x 560 mm. / 19.48 x 4.92 x 22.05 in.
Shipping weight	7,5 kg / 16.53 lb



HW	Ctrl. SW
PRECAUTIONS	HADA DSP MANAGER & Updates
WARRANTY & ENVIRONMENT	First Steps
PACKAGE CONTENTS	Automatic Connection with PC
DESCRIPTION & FEATURES	Login
PANEL FUNCTIONS	Main Screen
INSTALL & CONNECT	Device Configuration
START-UP & OPERATION	Admin Mode
TECHNICAL DATA	Groups
	TELNET Control

8.1.4 HADA-4B500

HADA-4B500

INPUTS		
Number of Inputs	4 analogue input channels	
Analogue input connection type	IN1-4: 3-pin Euroblock, balanced, pitch 3,5 mm.	
Input configuration	Digital matrix 4 in x 4 amp. out (Settings by HADA DSP Manager)	
AMPLIFIED OUTPUTS		
Number of amplified outputs	4	
Amplified output connection type	2-pin Euroblock.	
Output configuration	Lo-Z/Hi-Z, 70V/100V, 4Ω/8Ω Output mode selection per channel/couple by software (Settings by HADA DSP Manager)	
OUTPUT POWER (all channels driven @ 1%THD)		
Max output power @ 8Ω	250W	
Max output power @ 4Ω	500W	
Max output power @ 8Ω bridge mode	1000W	
Max output power @ 100V	1000W (Bridge mode)	
Max output power @ 70V	1000W (Bridge mode)	
SIGNAL		
Voltage gain	31 to 37 dBV 33,2 to 39,2 dBu	
Input sensitivity	-12 to 12 dBV -9,8 to 14,2 dBu 0,25 to 3,98 Vrms @ Nominal power	
Input impedance	21k (balanced)	
Max input level	22 dBV 24,2 dBu	
Frequency response	20Hz-20kHz (-3dB, 1W any load)	
THD + Noise	< 0,01 0.015 Typ (@ 1kHz, from 0,1W to Full Power)	
Crosstalk	>80dB (@ 1kHz)	
ELECTRICAL		
Power supply	Universal, SMPS with PFC	
AC mains requirement	100-240 V @ 50-60Hz (±10%)	
Power factor correction	> 0,92	
AC mains connector	IEC C14 inlet	
POWER CONSUMPTION @230VAC		
Power Consumption (1/4 POWER, @ 4Ω)	827W (all channels driven)	
Power Consumption (1/8 POWER, @ 4Ω)	427W (all channels driven)	
Power Consumption (IDLE)	25.5W	
Power Consumption (STBY)	20W	
TECHNOLOGIES		
Amplification technology	Class D	
Cooling	Fan (Forced air, front to back airflow. Temperature controlled continuously variable speed)	
Maximum fan noise	46dB (Maximum acoustical noise @1m)	



HW
Ctrl. SW

PRECAUTIONS
HADA DSP MANAGER & Updates

WARRANTY & ENVIRONMENT
First Steps

PACKAGE CONTENTS
Automatic Connection with PC

DESCRIPTION & FEATURES
Login

PANEL FUNCTIONS
Main Screen

INSTALL & CONNECT
Device Configuration

START-UP & OPERATION
Admin Mode

TECHNICAL DATA
Groups

TECHNICAL DATA
TELNET Control

TECHNICAL DATA

PROTECTIONS		
DC protection	Yes (Protects loudspeaker and installation against DC and infrasonic signals at the outputs)	
HF protection	Yes (Protects the loudspeakers against non-audible, strong, non-musical high frequency signals)	
Short-circuit protection	Yes (Protects the amplifier from overcurrent, short circuit or other stressful events for the output stages with output reduction or MUTE (automatic protection reset))	
Thermal protection	Yes (Output power reduction when output stages operating temperature up to 90 °C (194 °F) Mute when output stages operating temperature up to 100 °C (212 °F))	
REMOTE CONTROL CONNECTIONS		
ON / OFF	No	
GPIs	x4 GPIs (0-3.3V) (5-pin Euroblock connector, rear panel)	
External MUTE	Yes, dry contact (2 pins Euroblock connector, rear panel. Euroblock pitch 3,5 mm)	
LOCAL CONTROL		
Attenuators	Front panel knobs (Defaults: Amplified OUTs attenuators)	
Output mode settings	Lo-Z/Hi-Z, 70V/100V, 4Ω/8Ω Output mode selection per couple of channels (Software)	
RUN/SLEEP mode	Yes, front panel push-button (Operates when pressed more than 3 seconds)	
Power ON/OFF	Yes, back panel switch (Red LED indicator)	
CONNECTIVITY		
Ethernet	Ethernet Base-Tx 100Mb (CAT5 up to 100m. Settings by embedded web application)	
Programming and control	HADA DSP Manager Application	
MONITORING		
Signal Present	SP LED (White) per channel (trigger @- 40 dBV)	
Clipping	CLIP LED (Red) per channel	
Limit	LIMIT LED (Red) per channel	
Mute	MUTE LED (White) per channel	
Prot.	PROT. LED (Red) per unit	
Thermal	THERMAL LED (Red) per unit (Temperature limiter)	
Ext. Mute	ext. MUTE LED (White) per unit (OFF NO WIRE, ON when MASTER, BLINK when SLAVE)	
Data	DATA LED (White) per unit (ON when DATA)	
On	ON LED (White) per unit (ON when RUN, SLOW BLINK when SLEEP by BUTTON, FAST BLINK when SLEEP by AUTOSTBY, VERY FAST BLINK when HW Fault)	
DIGITAL ENGINE		
Processor	Dual core 64bits	
AUDIO CONVERTERS		
Sampling rate	96 kHz	
Resolution	24 bit	
Dynamic range	113 dB	



HW
Ctrl.
SW

HADA DSP MANAGER &
Updates

PRECAUTIONS
WARRANTY &
ENVIRONMENT

First Steps

Automatic
Connection with PC

DESCRIPTION &
FEATURES

Login

Main Screen

PANEL FUNCTIONS

Device
Configuration

Admin Mode

Groups

START-UP & OPERATION

TELENET Control

TECHNICAL DATA

PROCESSING	
Digital processing	64 bit
Latency	500uS (Analogue IN to analogue OUT)
Inputs processing	Delay, Parametric EQ, Limiter, Multiband compressor (Settings via HADA DSP Manager)
Outputs processing	Delay, Parametric EQ, Limiter, Multiband compressor (Settings via HADA DSP Manager)
Others	Preset management, 4x4 Matrix Mixer (Settings via HADA DSP Manager)
PHYSICAL	
Operating temperature	Min. 0°C; 32°F Max. 40°C; 104°F (performance may be reduced above 40°C)
Operating humidity	5 - 80% RH, non-condensing
Storage temperature	Min. -10°C; 14°F Max. 50°C; 122°F
Storage humidity	5 - 85% RH, non-condensing
Installation options	Rack 19" installation & desktop
Included accessories	EU Main cord, Euroblock Connectors (inputs /outputs), Desktop feet, rack 19" installation hardware
Optional accessories	-
Dimensions (WxHxD)	482.6 x 88 x 281,5 mm / 19 x 3.46 x 11.08 in.
Weight	5.6 Kg / 12.35 lb
Shipping dimensions (WxHxD)	495 x 125 x 560 mm / 19.48 x 4.92 x 22.05 in.
Shipping weight	7,7 8 kg / 16.97 lb



HW	Ctrl. SW
PRECAUTIONS	HADA DSP MANAGER & Updates
WARRANTY & ENVIRONMENT	First Steps
PACKAGE CONTENTS	Automatic Connection with PC
DESCRIPTION & FEATURES	Login
PANEL FUNCTIONS	Main Screen
INSTALL & CONNECT	Device Configuration
START-UP & OPERATION	Admin Mode
TECHNICAL DATA	Groups
	TELNET Control

8.1.5 HADA-4B750

HADA-4B750

INPUTS	
Number of Inputs	4 analogue input channels
Analogue input connection type	IN1-4: 3-pin Euroblock, balanced, pitch 3,5 mm.
Input configuration	Digital matrix 4 in x 4 amp. out (Settings by HADA DSP Manager)
AMPLIFIED OUTPUTS	
Number of amplified outputs	4
Amplified output connection type	2-pin Euroblock.
Output configuration	Lo-Z/Hi-Z, 70V/100V, 4Ω/8Ω Output mode selection per channel/couple by software (Settings by HADA DSP Manager)
OUTPUT POWER (all channels driven @ 1%THD)	
Max output power @ 8Ω	400W
Max output power @ 4Ω	750W
Max output @ 8Ω bridge mode	1500W
Max output power @ 100V	1500W (Bridge Mode)
Max output power @ 70V	1500W (Bridge Mode)
SIGNAL	
Voltage gain	31 to 38 dBV 33,2 to 40,2 dBu
Input sensitivity	-12 to 12 dBV -9,8 to 14,2 dBu 0,25 to 3,98 Vrms @ Nominal power
Input impedance	21k (balanced)
Max input level	22 dBV 24,2 dBu
Frequency response	20Hz-20kHz (-3dB, 1W any load)
THD + Noise	< 0,01 0.015 Typ (@ 1kHz, from 0,1W to Full Power)
Crosstalk	>80dB (@ 1kHz)
ELECTRICAL	
Power supply	Universal, SMPS with PFC
AC mains requirement	100-240 V @ 50-60Hz (±10%)
Power factor correction	> 0,96
AC mains connector	IEC C14 inlet
POWER CONSUMPTION @230VAC	
Power Consumption (1/4 POWER, @ 4Ω)	1220W (all channels driven)
Power Consumption (1/8 POWER, @ 4Ω)	601W (all channels driven)
Power Consumption (IDLE)	23W
Power Consumption (STBY)	10W
TECHNOLOGIES	
Amplification technology	Class D
Cooling	Fan (Forced air, front to back airflow. Temperature controlled continuously variable speed)
Maximum fan noise	46 dB (Maximum acoustical noise @1m)



HW
Ctrl.
SW

PRECAUTIONS
HADA DSP MANAGER &
Updates

WARRANTY &
ENVIRONMENT
First Steps

PACKAGE
CONTENTS
Automatic
Connection with PC

DESCRIPTION &
FEATURES
Login

PANEL FUNCTIONS
Main Screen

INSTALL & CONNECT
Device
Configuration

START-UP & OPERATION
Admin Mode

TECHNICAL DATA
Groups

TECHNICAL DATA
TELNET Control

TECHNICAL DATA

PROTECTIONS		
DC protection	Yes (Protects loudspeaker and installation against DC and infrasonic signals at the outputs)	
HF protection	Yes (Protects the loudspeakers against non-audible, strong, non-musical high frequency signals)	
Short-circuit protection	Yes (Protects the amplifier from overcurrent, short circuit or other stressful events for the output stages with output reduction or MUTE (automatic protection reset))	
Thermal protection	Yes (Output power reduction when output stages operating temperature up to 90 °C (194 °F) Mute when output stages operating temperature up to 100 °C (212 °F))	
REMOTE CONTROL CONNECTIONS		
ON / OFF	No	
GPIs	x4 GPIs (0-3.3V) (5-pin Euroblock connector, rear panel)	
External MUTE	Yes, dry contact (2 pins Euroblock connector, rear panel. Euroblock pitch 3,5 mm)	
LOCAL CONTROL		
Attenuators	Front panel knobs (Defaults: Amplified OUTs attenuators)	
Output mode settings	Lo-Z/Hi-Z, 70V/100V, 4Ω/8Ω Output mode selection per couple of channels (Software)	
RUN/SLEEP mode	Yes, front panel push-button (Operates when pressed more than 3 seconds)	
Power ON/OFF	Yes, back panel switch (Red LED indicator)	
CONNECTIVITY		
Ethernet	Ethernet Base-Tx 100Mb (CAT5 up to 100m. Settings by embedded web application)	
Programming and control	HADA DSP Manager Application	
MONITORING		
Signal Present	SP LED (White) per channel (trigger @- 40 dBV)	
Clipping	CLIP LED (Red) per channel	
Limit	LIMIT LED (Red) per channel	
Mute	MUTE LED (White) per channel	
Prot.	PROT. LED (Red) per unit	
Thermal	THERMAL LED (Red) per unit (Temperature limiter)	
Ext. Mute	ext. MUTE LED (White) per unit (OFF NO WIRE, ON when MASTER, BLINK when SLAVE)	
Data	DATA LED (White) per unit (ON when DATA)	
On	ON LED (White) per unit (ON when RUN, SLOW BLINK when SLEEP by BUTTON, FAST BLINK when SLEEP by AUTOSTBY, VERY FAST BLINK when HW Fault)	
DIGITAL ENGINE		
Processor	Dual core 64bits	
AUDIO CONVERTERS		
Sampling rate	96 kHz	
Resolution	24 bit	
Dynamic range	113dB	



HW
Ctrl.
SW

HADA DSP MANAGER &
Updates

PRECAUTIONS
WARRANTY &
ENVIRONMENT

First Steps

Automatic
Connection with PC

DESCRIPTION &
FEATURES

Login

Main Screen

PANEL FUNCTIONS

Device
Configuration

Admin Mode

Groups

START-UP & OPERATION

TELNET Control

TECHNICAL DATA

PROCESSING	
Digital processing	64 bit
Latency	500uS (Analogue IN to analogue OUT)
Inputs processing	Delay, Parametric EQ, Limiter, Multiband compressor (Settings via HADA DSP Manager)
Outputs processing	Delay, Parametric EQ, Limiter, Multiband compressor (Settings via HADA DSP Manager)
Others	Preset management, 4x4 Matrix Mixer (Settings via HADA DSP Manager)
PHYSICAL	
Operating temperature	Min. 0°C; 32°F Max. 40°C; 104°F (performance may be reduced above 40°C)
Operating humidity	5 - 80% RH, non-condensing
Storage temperature	Min. -10°C; 14°F Max. 50°C; 122°F
Storage humidity	5 - 85% RH, non-condensing
Installation options	Rack 19" installation & desktop
Included accessories	EU Main cord, Euroblock Connectors (inputs /outputs), Desktop feet, rack 19" installation hardware
Optional accessories	-
Dimensions (WxHxD)	482.6 x 88 x 281,5 mm / 19 x 3.46 x 11.08 in.
Weight	6.0 Kg / 13.22 lbs
Shipping dimensions (WxHxD)	495 x 125 x 560 mm / 19.48 x 4.92 x 22.05 in.
Shipping weight	8,1 kg / 17,85 lb



HW Ctr. SW

PRECAUTIONS HADA DSP MANAGER & Updates

WARRANTY & ENVIRONMENT First Steps

PACKAGE CONTENTS Automatic Connection with PC

DESCRIPTION & FEATURES Login

PANEL FUNCTIONS Main Screen

INSTALL & CONNECT Device Configuration

START-UP & OPERATION Admin Mode

TECHNICAL DATA Groups

TECHNICAL DATA TELNET Control

TECHNICAL DATA

8.2 Mechanical Diagrams

8.2.1 HADA-4B150

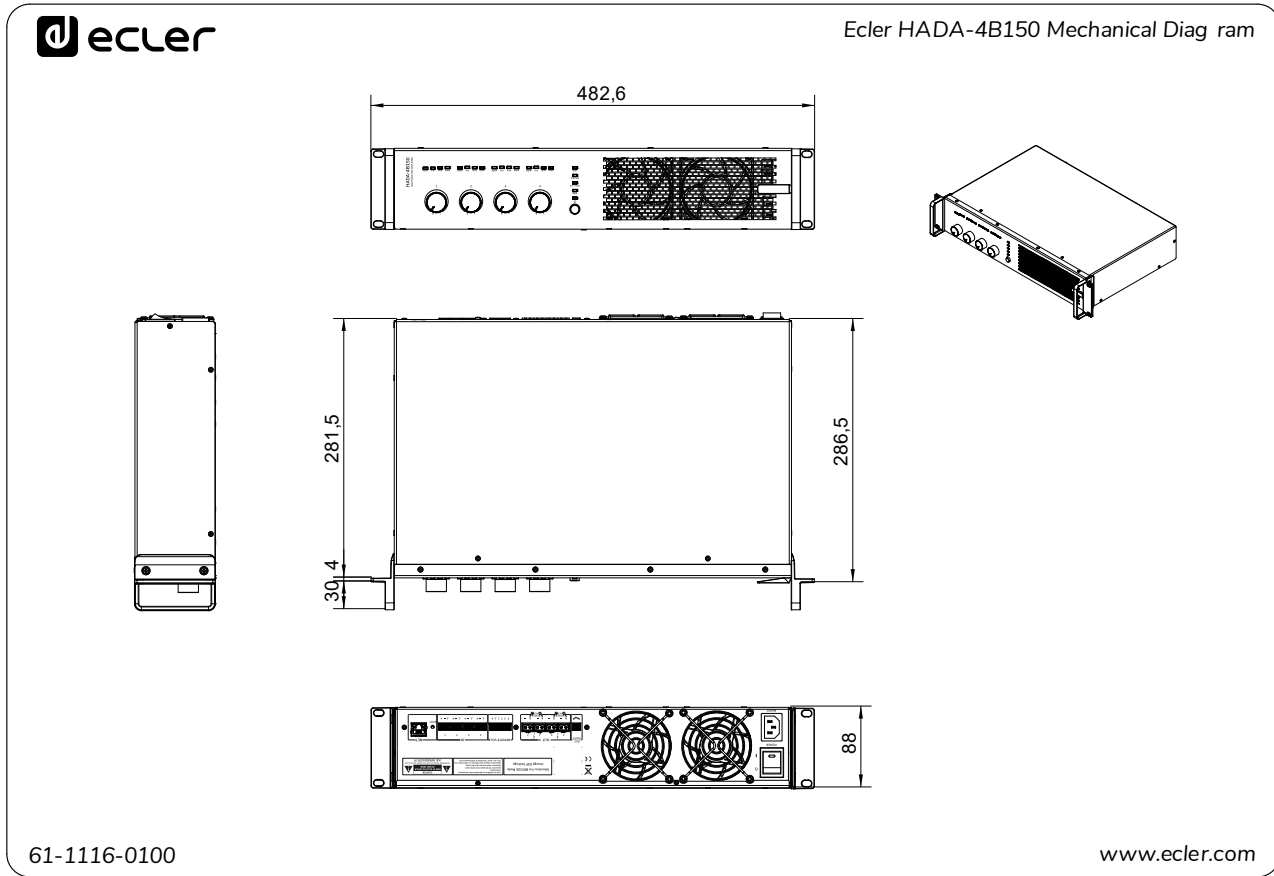

All the measurements are in mm



HW	Ctrl. SW	HADA DSP MANAGER & Updates	First Steps	Automatic Connection with PC	Login	Main Screen	Device Configuration	Admin Mode	Groups	TELNET Control	TECHNICAL DATA
PRECAUTIONS	WARRANTY & ENVIRONMENT	PACKAGE CONTENTS	DESCRIPTION & FEATURES	PANEL FUNCTIONS	INSTALL & CONNECT	START-UP & OPERATION					

8.2.2 HADA-4B250

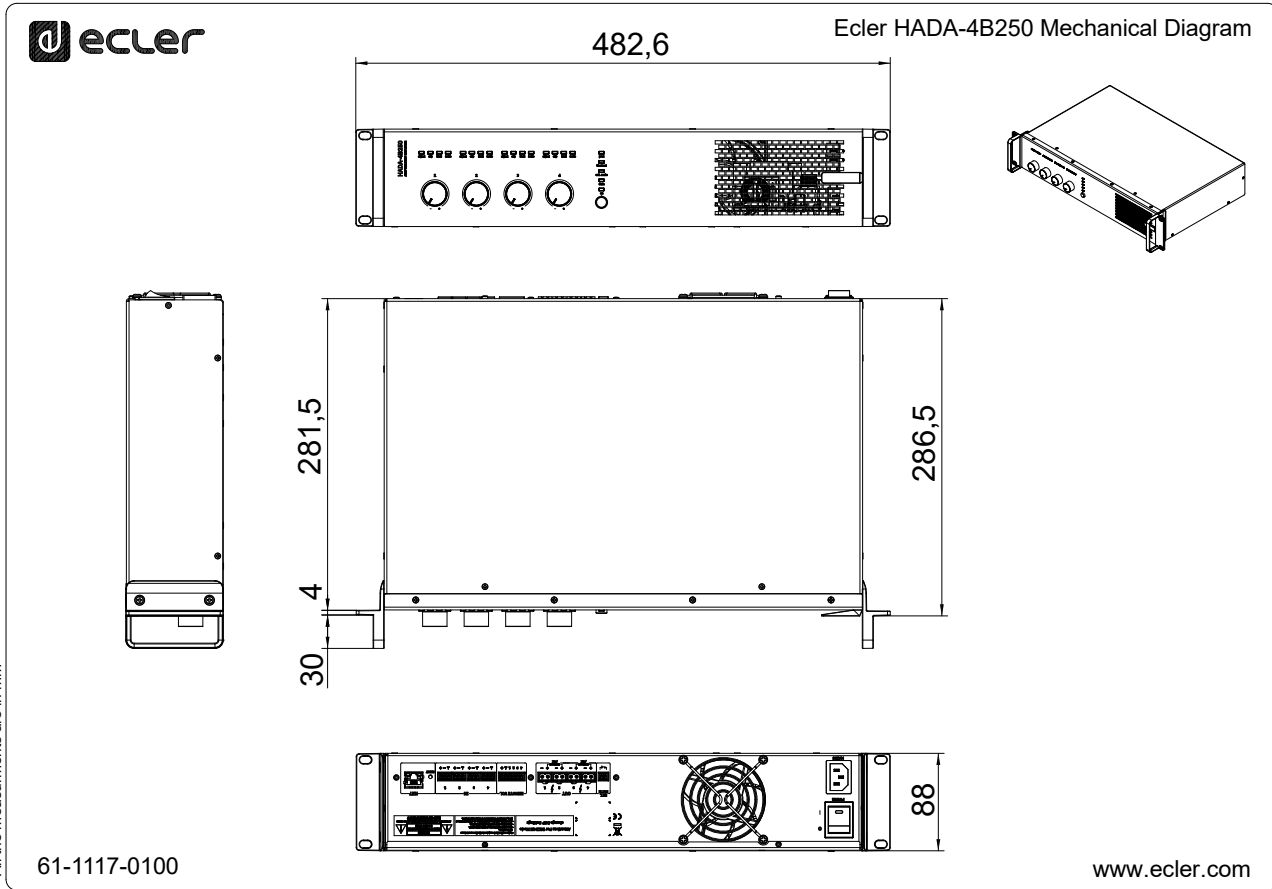

All the measurements are in mm



HW	Ctrl. SW	HADA DSP MANAGER & Updates	First Steps	Automatic Connection with PC	Login	Main Screen	Device Configuration	Admin Mode	Groups	TELNET Control	TECHNICAL DATA
PRECAUTIONS	WARRANTY & ENVIRONMENT	PACKAGE CONTENTS	DESCRIPTION & FEATURES	PANEL FUNCTIONS	INSTALL & CONNECT	START-UP & OPERATION					

8.2.3 HADA-4B400

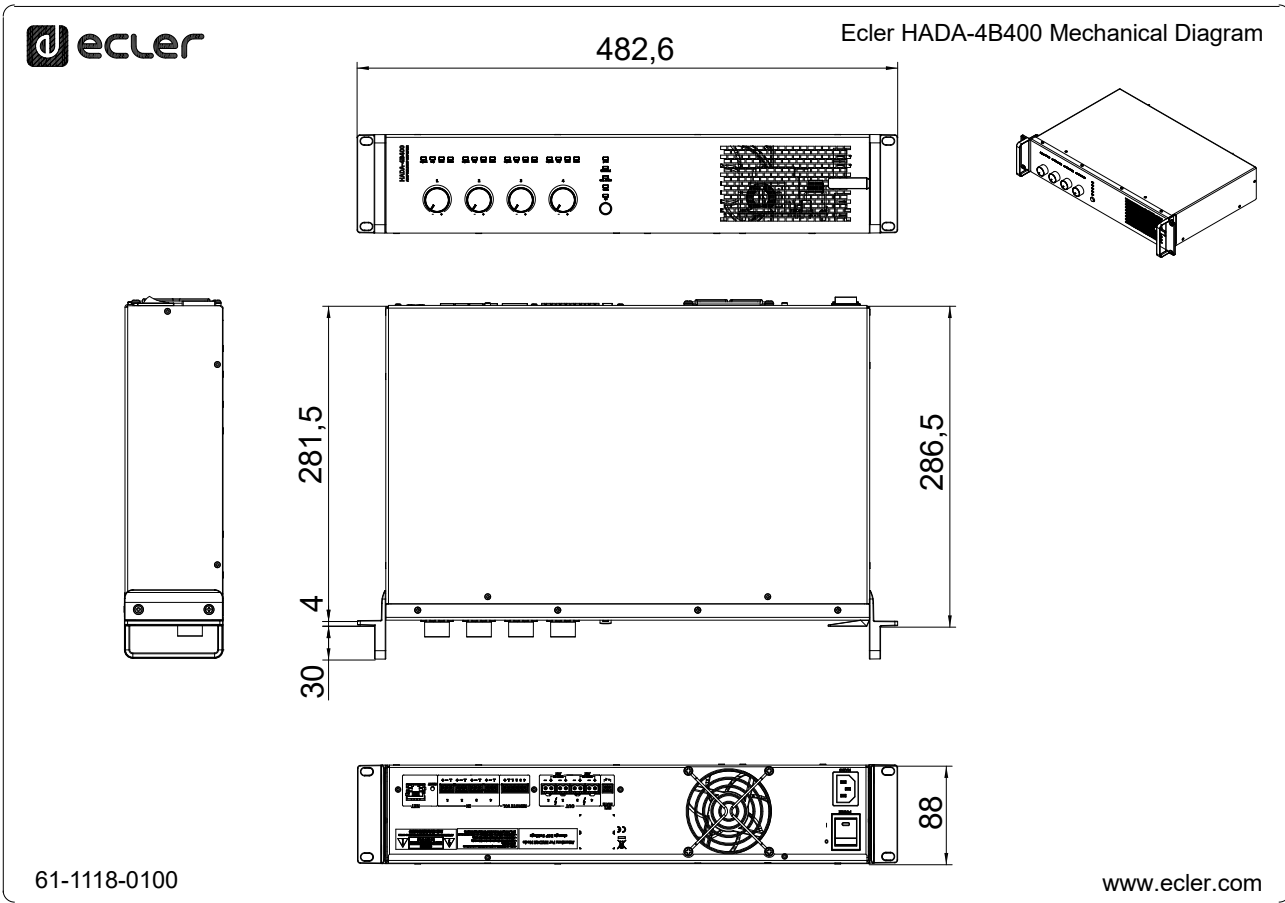

HW	Ctrl. SW	HADA DSP MANAGER & Updates	First Steps	Automatic Connection with PC	Login	Main Screen	Device Configuration	Admin Mode	Groups	TELNET Control	TECHNICAL DATA
PRECAUTIONS	WARRANTY & ENVIRONMENT	PACKAGE CONTENTS	DESCRIPTION & FEATURES	PANEL FUNCTIONS	INSTALL & CONNECT	START-UP & OPERATION					

8.2.4 HADA-4B500

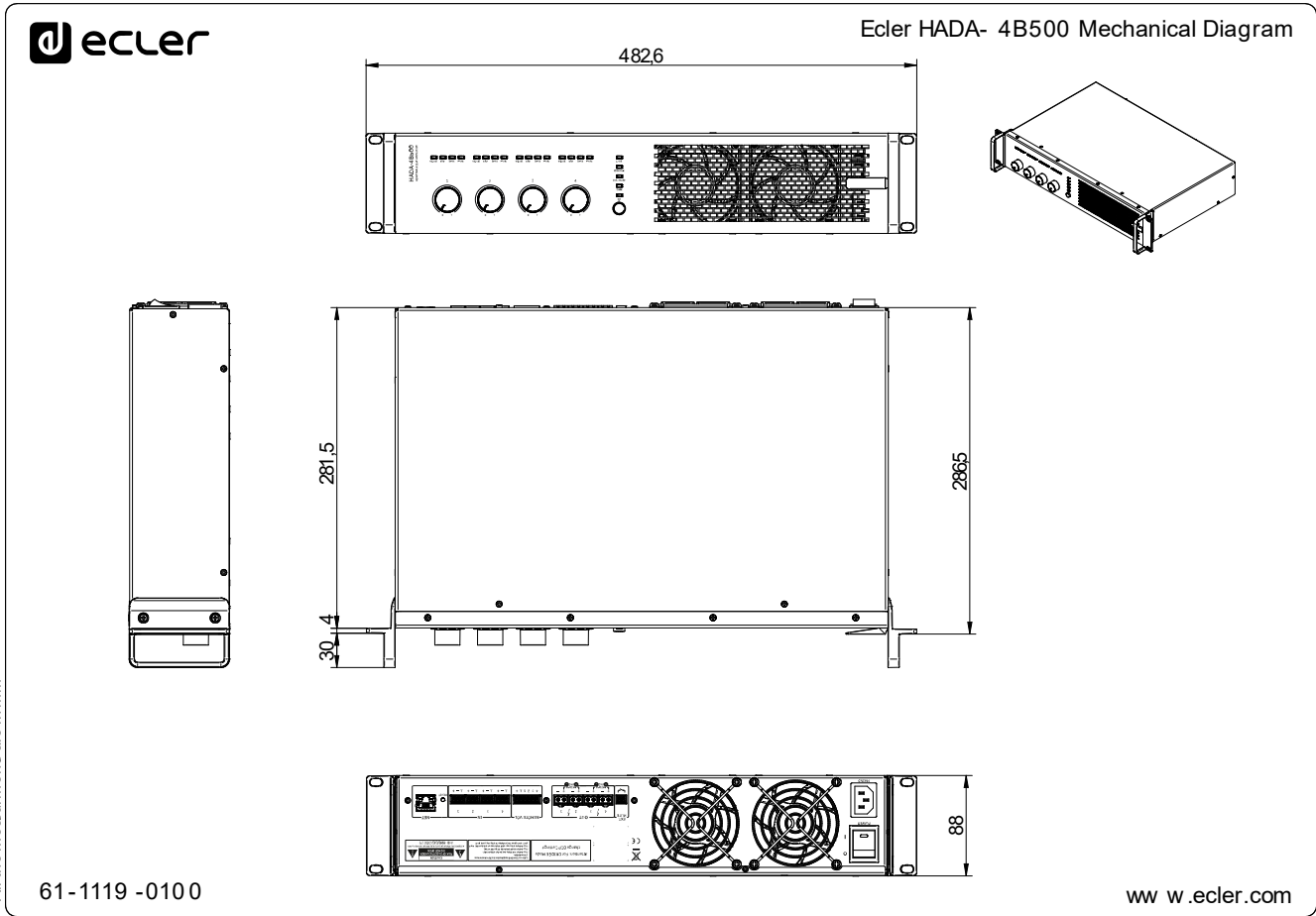

All the measurements are in mm



HW	Ctrl. SW	HADA DSP MANAGER & Updates	First Steps	Automatic Connection with PC	Login	Main Screen	Device Configuration	Admin Mode	Groups	TELNET Control	TECHNICAL DATA
PRECAUTIONS	WARRANTY & ENVIRONMENT	PACKAGE CONTENTS	DESCRIPTION & FEATURES	PANEL FUNCTIONS	INSTALL & CONNECT	START-UP & OPERATION					

8.2.5 HADA-4B750

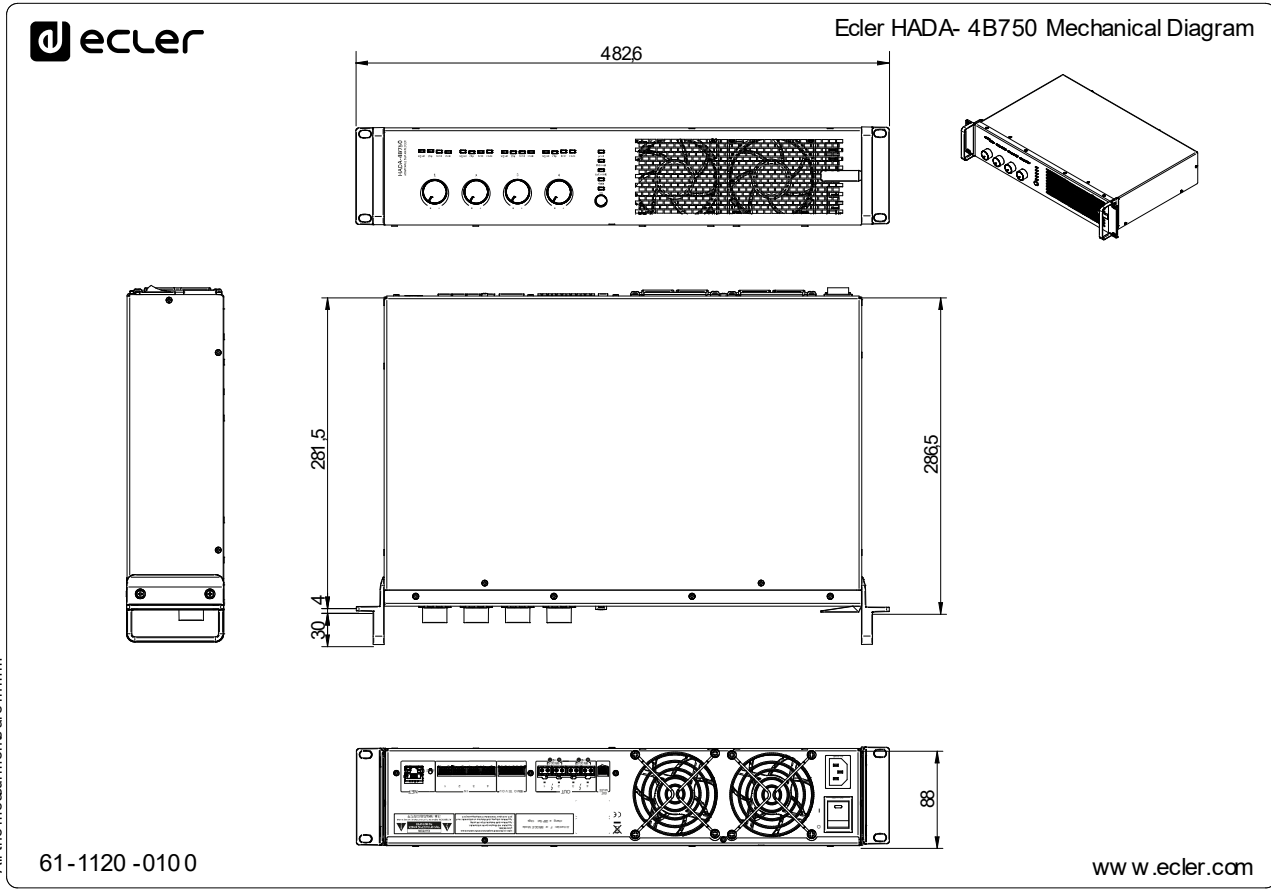

HW	Ctrl. SW	HADA DSP MANAGER & Updates	First Steps	Automatic Connection with PC	Login	Main Screen	Device Configuration	Admin Mode	Groups	TELNET Control	TECHNICAL DATA
PRECAUTIONS	WARRANTY & ENVIRONMENT	PACKAGE CONTENTS	DESCRIPTION & FEATURES	PANEL FUNCTIONS	INSTALL & CONNECT	START-UP & OPERATION					

9. HADA DSP MANAGER

HADA series digital amplifiers are configured and controlled through their windows application HADA DSP Manager. This interface allows programming and control devices through different access levels.

 **Demo version available with no physical connection!** Visit our website www.ecler.com and [download the HADA DSP Manager software ready to be used in DEMO mode](#) to explore the capabilities of these devices. Note that **some features**, such as firmware update or output mode among others, **require a physical connection to HADA device**.

9.1 Updates

- **Current version: V1.00 (March 2024):**
 - Official release version of HADA Series.

9.2 First Steps

To access the HADA DSP Manager software, it is necessary to [download and install the Windows application by clicking on this link](#).

 First, make sure that both devices are physically connected to the same local area network (LAN), and configured as DHCP clients.

HADA device is in DHCP network configuration mode by factory default. If you have a router/switch with a DHCP server (see the specifications for your device), **network configuration is automatic** so there is no need for you to do any re-configuration.

 If new software releases are installed, it is necessary to uninstall the previous version via the Windows program manager.

HW	Ctrl. SW	HADA DSP MANAGER & Updates	First Steps	Automatic Connection with PC	Login	Main Screen	Device Configuration	Admin Mode	Groups	TELNET Control	TECHNICAL DATA
PRECAUTIONS	WARRANTY & ENVIRONMENT	PACKAGE CONTENTS	DESCRIPTION & FEATURES	PANEL FUNCTIONS	INSTALL & CONNECT	START-UP & OPERATION					

9.3 Automatic Connection using a Computer

1. Connect the HADA device to the router/switch or point to point by using a CAT5 or higher cable.
2. Set your computer to DHCP client mode by selecting "obtain an IP address automatically" in the network settings (this is the usual default setting).
3. Open the HADA DSP Manager application. All HADA units connected to your network will be listed.

In the event that some HADA unit is static IP configured instead of the factory network settings, it will be necessary to configure the computer's network card the same network range in order the application locate all units.

4. Once HADA units connected to the network appear listed on the screen, click on the arrow to the right of the unit to open the configuration window of the selected one.

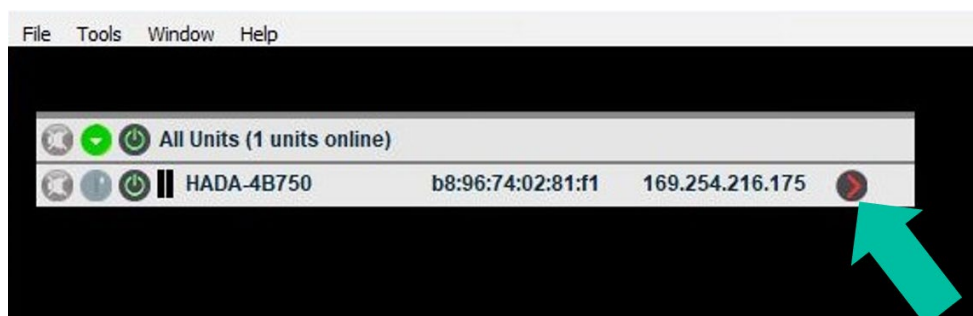

In the event that your HADA amplifier does not appear, please reset the unit. [For further details, please refer to the Reset chapter.](#)



HW
Ctrl.
SW

HADA DSP MANAGER &
Updates
PRECAUTIONS

WARRANTY &
ENVIRONMENT
First Steps

PACKAGE
CONTENTS
Automatic
Connection with PC

DESCRIPTION &
FEATURES
Login

PANEL FUNCTIONS
Main Screen

INSTALL & CONNECT
Device
Configuration

START-UP & OPERATION
Admin Mode

TECHNICAL DATA
Groups

TECHNICAL DATA
TELNET Control

TECHNICAL DATA

9.4 Login

There are 2 profiles that can access the app:

1. **Admin:** An administrator has access to all features of the HADA device, is allowed to configure any parameter of the amplifier as well as assigning password to the users who will have limited access to the features.
2. **User:** the user has limited access. The only role available to users is as controllers and restrictions will be determined by the administrator.

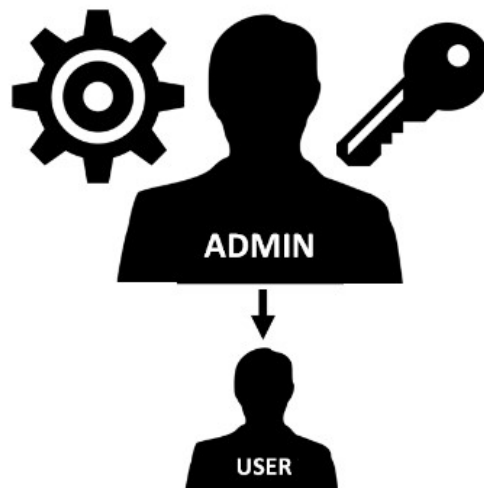

Administrator access is password-protected. Enter the password in "Hardware > Enter Password":

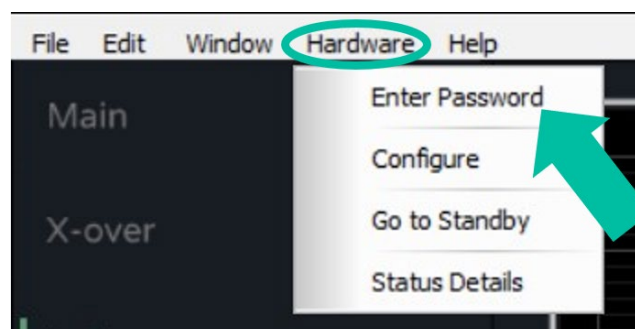

- Password (by default): admin

The administrator can change his own access password from the HADA DSP Manager application and, in addition, can manage the user rights.

Usernames and passwords are case-sensitive.

The user has no password preset by default. To switch from administrator mode to user mode, simply leave the password field empty and press "enter" on the keyboard.

HW	Ctrl. SW	HADA DSP MANAGER & Updates	First Steps	Automatic Connection with PC	Login	Main Screen	Device Configuration	Admin Mode	Groups	TELNET Control	TECHNICAL DATA
		PRECAUTIONS	WARRANTY & ENVIRONMENT	PACKAGE CONTENTS	DESCRIPTION & FEATURES	PANEL FUNCTIONS	INSTALL & CONNECT	START-UP & OPERATION			

9.5 Main Screen

HADA DSP Manager main screen elements:

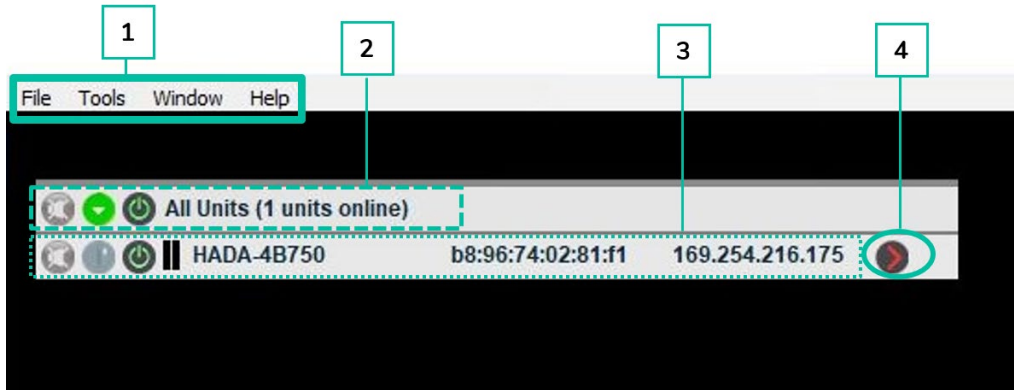

1. App bar allows to perform actions on the projects and on general settings.
2. Displays information on the number of connected units listed on the main screen.
3. Displays information about each of the connected units listed.



When the application is opened, all HADA units connected to your network will be listed.

In the event that some HADA unit is static IP configured instead of the factory network settings, it will be necessary to configure the computer's network card the same network range in order the application locate all units.

4. Press to access the configuration menu for the selected device.



Features of the main screen menu are detailed in the following chapters.



HW	Ctrl. SW	HADA DSP MANAGER & Updates	First Steps	Automatic Connection with PC	Login	Main Screen	Device Configuration	Admin Mode	Groups	TELNET Control	TECHNICAL DATA
PRECAUTIONS	WARRANTY & ENVIRONMENT	PACKAGE CONTENTS	DESCRIPTION & FEATURES	PANEL FUNCTIONS	INSTALL & CONNECT	START-UP & OPERATION					

9.5.1 File

Project management functions for replication or replacement in case of hardware changes.



- **New Project:** select to create a new project.
- **Open Project:** select to open an existing project.
- **Save Project:** select to save the new created project.

9.5.2 Tools

Application configuration options.

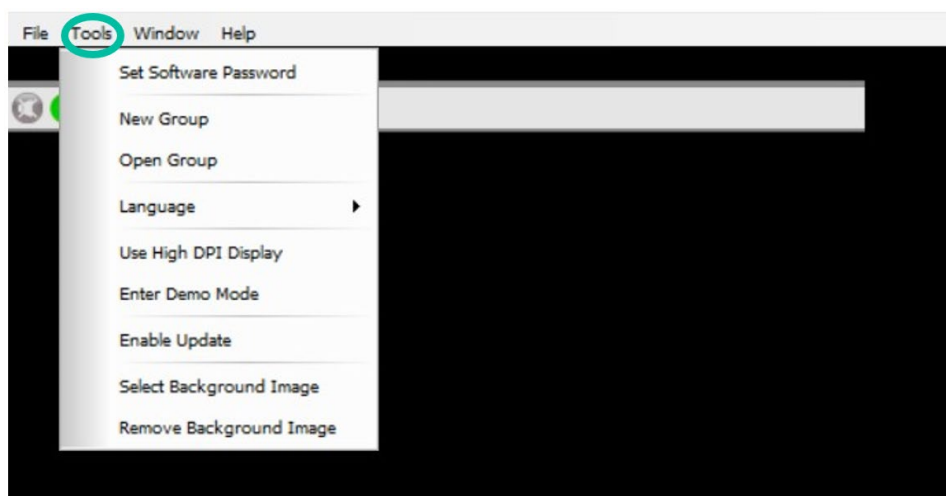

- **Set Software Password:** lets you assign a password to access the HADA DSP Manager.



To disable this feature, simply leave the password blank.

- **New Group:** lets you create a group of devices and control some parameters, such as mute and volume, simultaneously.
- **Open Group:** lets you open a device group previously created.



For further information, please [refer to the Groups chapter](#).

- **Language:** lets you choose the UI language.



HW	Ctrl. SW	HADA DSP MANAGER & Updates	First Steps	Automatic Connection with PC	Login	Main Screen	Device Configuration	Admin Mode	Groups	TELNET Control	TECHNICAL DATA
PRECAUTIONS	WARRANTY & ENVIRONMENT	PACKAGE CONTENTS	DESCRIPTION & FEATURES	PANEL FUNCTIONS	INSTALL & CONNECT	START-UP & OPERATION					

- **Use High DPI display:** lets you modify the UI display size in case of using computers with high screen resolution.
- **Enter Demo Mode:** lets you explore the HADA DSP Manager functionalities without being physically connected to a device.
- **Enable Update:** By assigning a password it is possible to enable or disable the firmware update feature on main menu.
- **Select Background Image:** lets you upload a background image on the app, such as floor plans to help the user to use the groups in a more intuitive and user-friendly way.
- **Remove Background Image:** lets you remove the current background image in use.



For more information, [refer to Groups chapter](#).

9.5.3 Window

To manage the amplifier and group configuration windows.

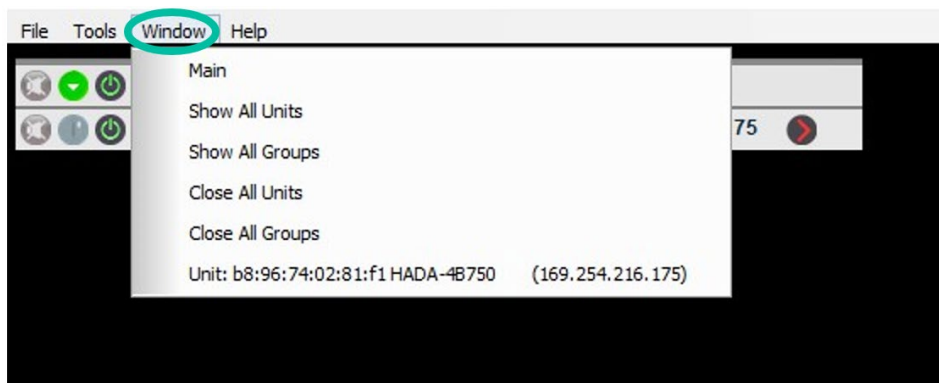

- **Main:** redirects to the main menu of HADA DSP Manager.
- **Show All Units:** opens the configuration windows of connected amplifiers.
- **Show All Groups:** opens all the configuration windows of created groups.
- **Close All Units:** closes all configuration windows of connected amplifiers.
- **Close All Groups:** closes all the configuration windows of all the groups.
- **Unit:** opens the configuration window of the indicated amplifier.



HW	Ctrl. SW	HADA DSP MANAGER & Updates	First Steps	Automatic Connection with PC	Login	Main Screen	Device Configuration	Admin Mode	Groups	TELNET Control	TECHNICAL DATA
		PRECAUTIONS	WARRANTY & ENVIRONMENT	PACKAGE CONTENTS	DESCRIPTION & FEATURES	PANEL FUNCTIONS	INSTALL & CONNECT	START-UP & OPERATION			

9.5.4 Help

Provides technical support and software version info.

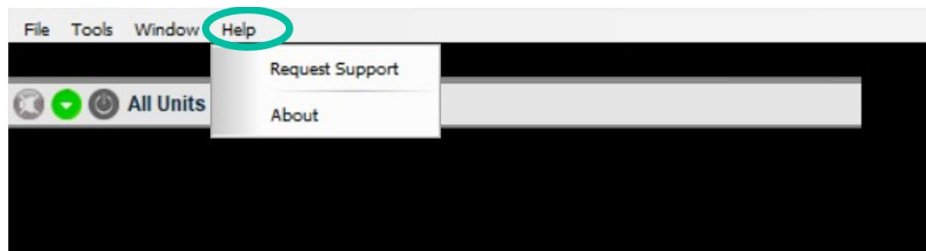

- **Request Support:** automatically redirects to the Ecler Support website.
- **About:** provides info about the software version.

9.6 Device Configuration

Allows to configure all parameters of the HADA amplifier according to the selected user type.

- **User mode:** The HADA DSP Manager software is **connected** to the amplifier **with user credentials by default**. This profile does **not require a password**. The administrator (admin) is allowed to limit the features to the end-user. [For further details see chapter Change Access Rights for User level.](#)

By default, the user mode has no access to the load type configuration (4 Ohm, 8 Ohm, 8 Ohm Bridge, 100V, 70V), nor saving presets, but is only able to load the presets saved by the administrator and is not permitted to update the firmware of the devices.

- **Admin mode:** is intended for installers and allows access to all amplifier configuration parameters.

From the HADA DSP Manager main screen, **click on the arrow to the right of the unit to access the configuration menu of the selected unit.**

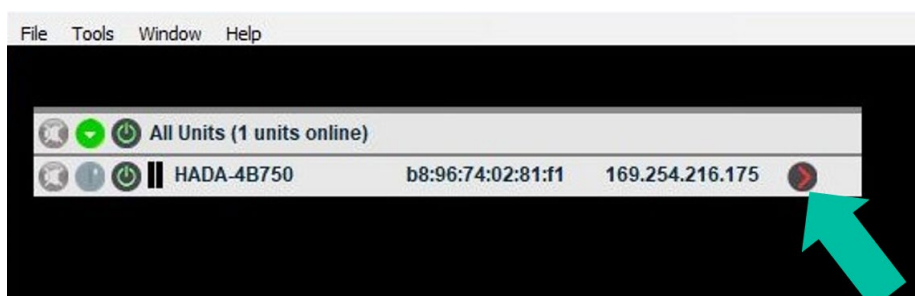

HW	Ctrl. SW	HADA DSP MANAGER & Updates	First Steps	Automatic Connection with PC	Login	Main Screen	Device Configuration	Admin Mode	Groups	TELNET Control
		PRECAUTIONS	WARRANTY & ENVIRONMENT	PACKAGE CONTENTS	DESCRIPTION & FEATURES	PANEL FUNCTIONS	INSTALL & CONNECT	START-UP & OPERATION	TECHNICAL DATA	



1. Configuration window bar lets you access to the device features.
2. Setting options lets you select the device settings options.
3. Page displays all the configuration parameter options for the selected setting.

Features and options of the Device Configuration Menu are detailed in the following chapters.

9.6.1 File

To manage presets.

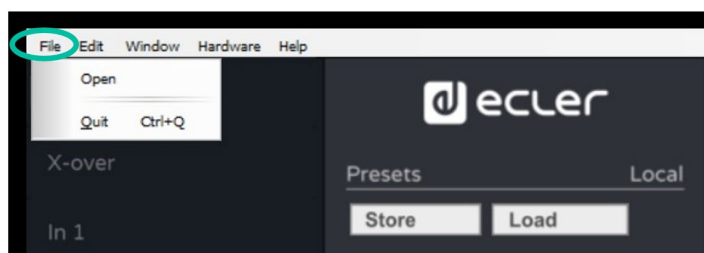

- **Open:** lets you load local presets previously saved on the PC by the admin.

Please note that with user profile it is only permitted to load presets, while with the administrator (admin) profile, loading and saving presets are permitted.

For further information on preset management, [please refer to the chapter Boot-Up Mode.](#)

- **Quit:** lets you close the configuration window.

HW	Ctrl. SW	HADA DSP MANAGER & Updates	First Steps	Automatic Connection with PC	Login	Main Screen	Device Configuration	Admin Mode	Groups	TELNET Control
		PRECAUTIONS	WARRANTY & ENVIRONMENT	PACKAGE CONTENTS	DESCRIPTION & FEATURES	PANEL FUNCTIONS	INSTALL & CONNECT	START-UP & OPERATION	TECHNICAL DATA	

9.6.2 Edit

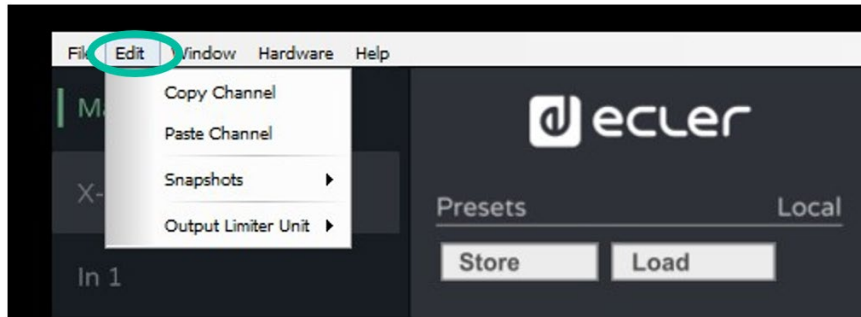

- **Copy Channel:** After selecting an input or output channel, this option lets you copy the channel DSP parameters for a quick replica to other channels.
- **Paste Channel:** lets you paste the copied parameters into another channel.
- **Snapshots:** "Make a snapshot" option lets you create "snapshots" of the DSP parameters and move them from one snapshot to another in a quick way by using "Restore", without the need to use the preset feature.

Restore feature allows you to view the record of changes and revert to previous configurations in case of errors.

This feature is **very useful for example when comparing volumes or equalizations.**

Example:

After creating two snapshots named EQ Zero (flat equalization) and EQ1, it is very easy to compare the two results by selecting the related snapshots.

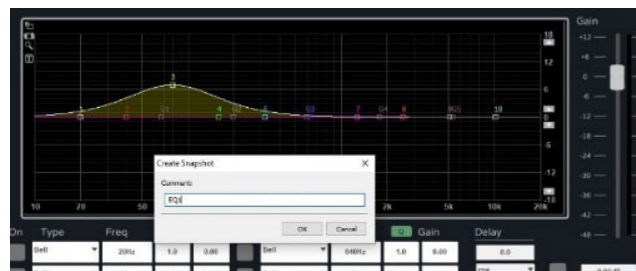

Snapshots will not be saved on the device. Therefore, so they will disappear at the end of the session.



- **Output Limiter Unit:** lets you to select the measurement unit for input and output limiters to facilitate the configuration depending on the system in use. Any of the following options can be selected:

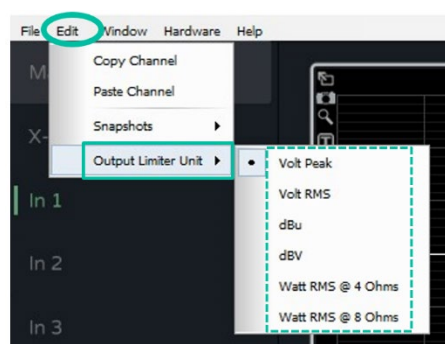

HW
Ctrl. SW

HADA DSP MANAGER &
Updates

PRECAUTIONS
WARRANTY &
ENVIRONMENT

First Steps

Automatic
Connection with PC

DESCRIPTION &
FEATURES

Login
Main Screen

Device
Configuration

Admin Mode

Groups

TELENET Control

START-UP & OPERATION

TECHNICAL DATA

9.6.3 Window

Allows **direct access to the unit configuration windows**, starting by the windows of all the units or the groups created.

In the same way it also lets you to quickly close all the configuration windows of the units or groups.

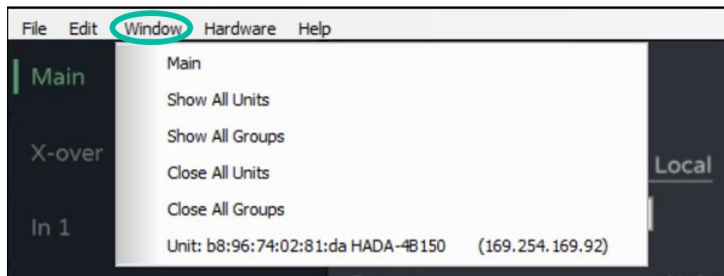

For further details on each one of the options in this menu, [please refer to the Window chapter of the HADA DSP Manager Main screen.](#)

9.6.4 Hardware

Allows access to password management and device status mode.

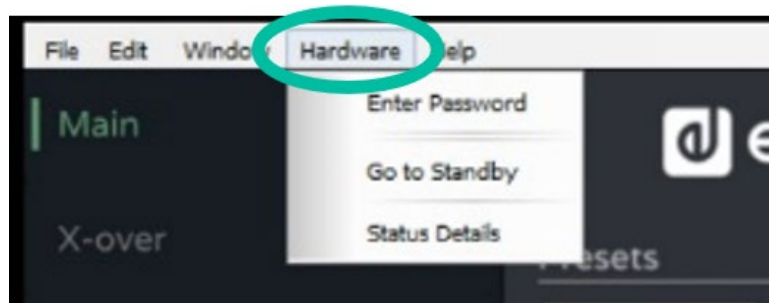

- **Enter Password:** this option automatically opens a window to enter the user or administrator password in order to access to configuration mode menus.
- **Go to Standby/Exit Standby:** to enter and exit Standby mode [in the same way as by the ON button on the front panel of the unit.](#)
- **Status details:** informs about the amplifier health status, indicating the current temperature and any possible errors detected by the DSP.

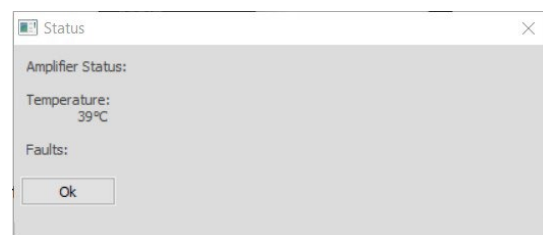

9.6.5 Help

Displays useful unit's information such as IP and MAC addresses and the firmware version in use as well.

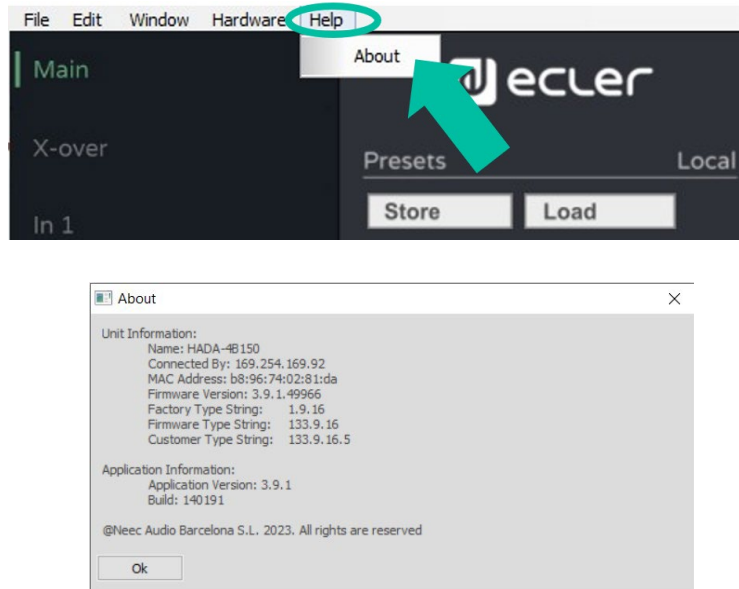

9.6.6 Main

Allows a global display of the amplifier signals status.

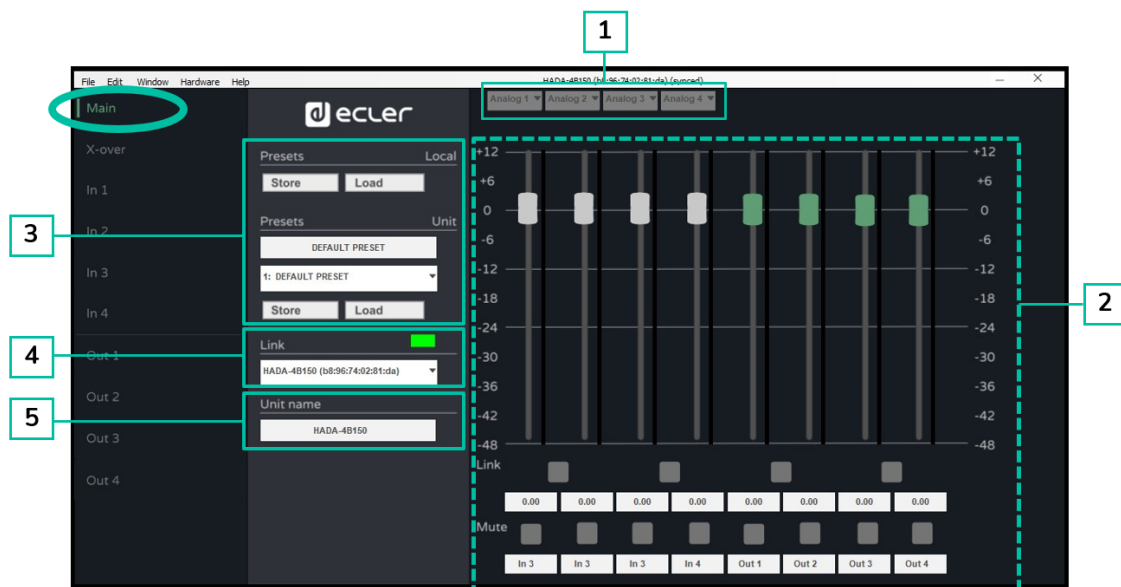

1. **Routing section** lets you select one of the following signals for each input:

This allows to assign to a DSP input the related analogue input, the sum of two inputs (if for example a mono sum is needed) or a signal coming from one of the internal generators.

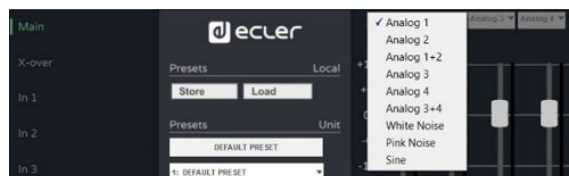

HW	Ctrl. SW	HADA DSP MANAGER & Updates	First Steps	Automatic Connection with PC	Login	Main Screen	Device Configuration	Admin Mode	Groups	TELNET Control
PRECAUTIONS	WARRANTY & ENVIRONMENT	PACKAGE CONTENTS	DESCRIPTION & FEATURES	PANEL FUNCTIONS	INSTALL & CONNECT	START-UP & OPERATION	TECHNICAL DATA			

2. **Display and Control section** displays the input and output levels through its VU meters. It is possible to modify the levels through the faders or by directly entering the values in the numerical boxes below the faders.

In addition, lets you link the faders (in the case of stereo inputs or outputs), activate or deactivate the input and output mute and, also, change the name of the inputs and outputs for easy identification.

3. **Presets section** lets you manage presets, saving or selecting presets stored in the memory of the unit itself or local presets (saved on the PC).

To save presets, it is necessary to access with administrator (admin) credentials.

4. **Link section** provides information on the status of the software connection. When LED is green the connection is active, while if it is red, it means that it is not connected.
5. **Unit Name section** lets you change the name of the unit.

9.6.7 X-over

This screen provides a **panoramic display of of each HP and LP filter configuration for the different outputs of the amplifier.** This will be very useful when using HADA amplifier as a crossover.

This allows the **crossover cut filters as well as the possible acoustic alignment delays of the loudspeakers to be displayed graphically on a single screen.**

It is also possible to **display the 4 outputs levels and manage their respective link, mute, and polarity as well.**

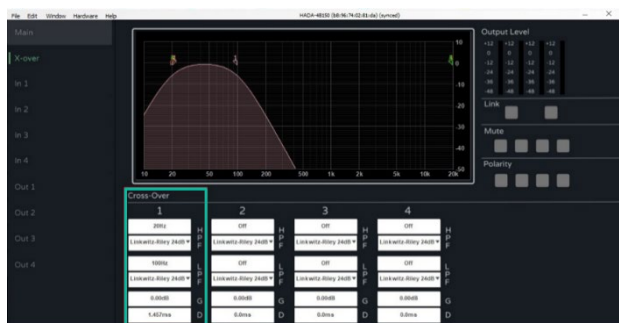

9.6.8 Inputs

To manage each of the 4 inputs of the HADA amplifier.



1. FILTERS

Each input has 10 selectable parametric filters.

For each filter it is possible to modify its frequency, bandwidth and gain.

By default, the bandwidth is indicated as resonance factor Q.

By clicking on the green Q button, the filter width can be expressed as a bandwidth in fractional octave (BW).



Each filter can be activated / deactivated by pressing the ON button.

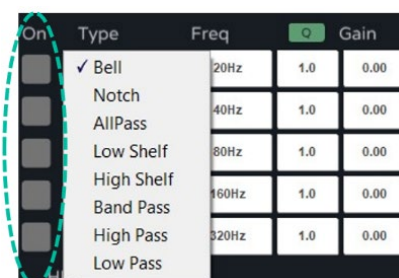

HW
Ctrl.
SW

HADA DSP MANAGER &
Updates

PRECAUTIONS
WARRANTY &
ENVIRONMENT

First Steps
Automatic
Connection with PC

PACKAGE
CONTENTS
DESCRIPTION &
FEATURES

Login
Main Screen

PANEL FUNCTIONS
Device
Configuration

INSTALL & CONNECT
Admin Mode

START-UP & OPERATION
Groups
TELNET Control

TECHNICAL DATA

In addition to the 10 parametric filters, a high-pass filter (HPF) and a low-pass filter (LPF) are available for each input. Typologies of these filters are as follows:

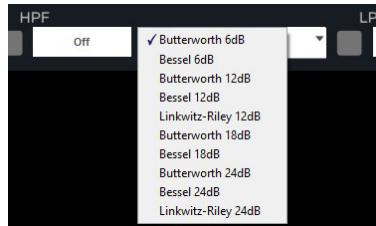

💡 Es posible asignar las frecuencias de corte a los filtros HPF y LPF escribiendo el valor de frecuencia en el campo de texto.

💡 To disable these filters, use the ON/OFF button or, alternatively, you can write 0 (zero) in the frequency field.

💡 The HPF and LPF filters are the same as those summarised in the [X-over chapter](#).

A Following screen options are available:



Full screen.



Screenshot to export the filter plots.



Zoom.



Textual indications on each filter.

2. DELAY

Each input has a delay module. Delay unit's measurement can be chosen between:

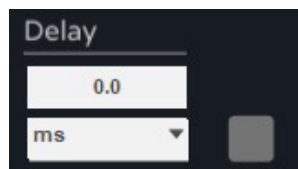

💡 The maximum delay value for the inputs is 40ms.

HW	Ctrl. SW	HADA DSP MANAGER & Updates	First Steps	Automatic Connection with PC	Login	Main Screen	Device Configuration	Admin Mode	Groups	TELNET Control	TECHNICAL DATA
PRECAUTIONS	WARRANTY & ENVIRONMENT	PACKAGE CONTENTS	DESCRIPTION & FEATURES	PANEL FUNCTIONS	INSTALL & CONNECT	START-UP & OPERATION					

3. LIMITER

The limiter works on the level of the input signal to the DSP. It is possible to modify the threshold value (by default in dBu) and the reaction times of the limiter as well.

4. POLARITY

Phase of the signal can be inverted with the polarity button.



When the button is active (blue), the phase is inverted.

5. COMPRESSOR

Click on the green "COMPRESSOR" button, to display the integrated multiband compressor control window.

This compressor includes 4 bands, and each band can be configured as follows:

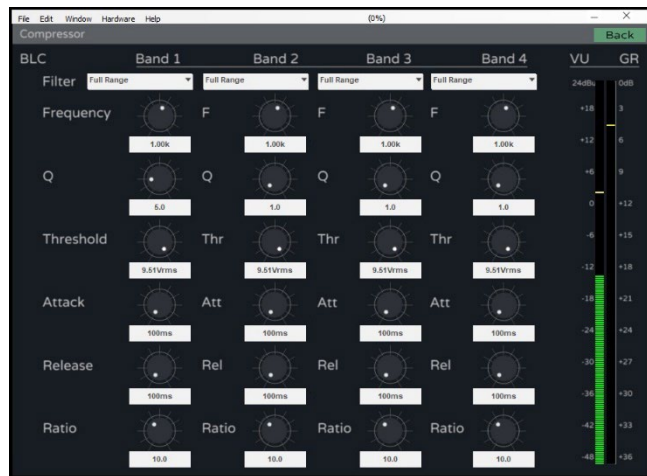

It can operate at different frequency, bandwidth, threshold and with adjustable reaction times. It shows the input signal level and the amount of gain reduction when the compressor is running.



To close the compressor configuration window and return to the programming window, press the green highlighted "Back" button to the right of Compressor.

6. GAIN

The Gain fader acts on the gain of the input channel before the matrix mixer and is a replica of the input fader on the Main screen as well as the mute button.



The measurement unit of the input limiter follows that of the output limiter and can be selected in the Edit menu of the setup menu.



HW	Ctrl. SW	HADA DSP MANAGER & Updates	First Steps	Automatic Connection with PC	Login	Main Screen	Device Configuration	Admin Mode	Groups	TELNET Control	TECHNICAL DATA
PRECAUTIONS	WARRANTY & ENVIRONMENT	PACKAGE CONTENTS	DESCRIPTION & FEATURES	PANEL FUNCTIONS	INSTALL & CONNECT	START-UP & OPERATION					

9.6.9 Outputs

Allows to manage each of the 4 outputs of the HADA amplifier.

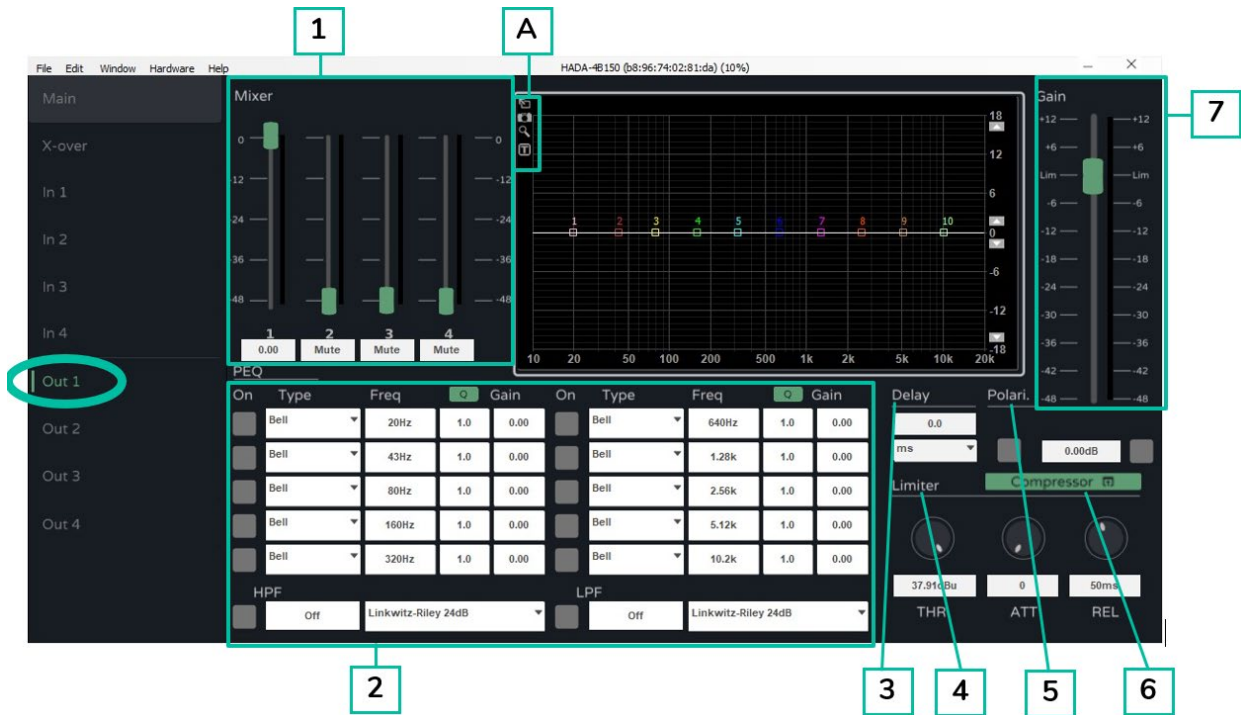

1. MIXER

The Mixer section of each output allows you to mix the different inputs before sending them to the amplifier module. By default, each input is assigned to the corresponding output.

2. FILTERS

Each output has 10 selectable parametric filters.

For each filter it is possible to modify its frequency, bandwidth and gain.

By default, the bandwidth is indicated as the resonance factor Q.

By clicking on the green Q button, the filter width can be expressed as a bandwidth in fractions of an octave (BW).

Each filter can be activated and deactivated via the ON button.

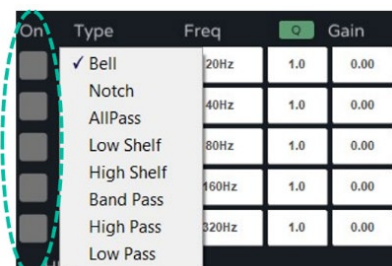

In addition to the 10 parametric filters, a high-pass filter (HPF) and a low-pass filter (LPF) are available for each input. Typologies for these filters are as follows:

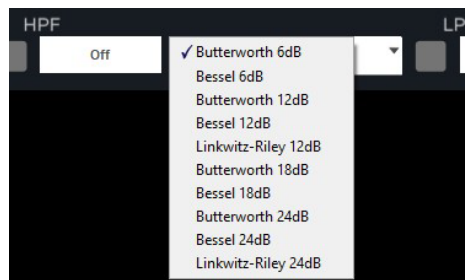

By typing the frequency value in the text field, it is possible to assign the cut-off frequencies to the HPF and LPF filters.

To disable these filters, use the ON/OFF button or type 0 (zero) in the frequency field instead.

The HPF and LPF filters are the same as those summarised in the [X-over chapter](#).

A Following screen options are available:



Full screen.



Screenshot to export the filter plots.



Zoom.



Textual indications on each filter.

3. DELAY

Each output has a delay module. Delay measurement unit can be selected between:

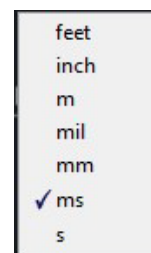
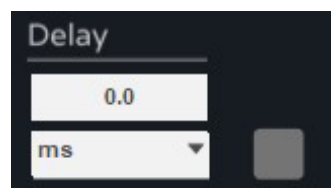

The maximum delay value for the outputs is 10ms.

HW	Ctrl. SW	HADA DSP MANAGER & Updates	First Steps	Automatic Connection with PC	Login	Main Screen	Device Configuration	Admin Mode	Groups	TELNET Control	TECHNICAL DATA
PRECAUTIONS	WARRANTY & ENVIRONMENT	PACKAGE CONTENTS	DESCRIPTION & FEATURES	PANEL FUNCTIONS	INSTALL & CONNECT	START-UP & OPERATION					

4. LIMITER

This limiter, unlike the input limiter, **allows limiting the level of the signal that will go to the amplifier module**. It is possible to modify the threshold value (in dBu) and the limiter reaction times as well.

The most typical application of this limiter is **to protect the loudspeakers in case their power is lower than the output power of the amplifier**.

The limiter measurement unit can be selected in the [Edit menu](#). The limiter can be configured in a very user-friendly way in relation to the speakers used by using the unit Watt RMS @ 4 Ohm or Watt RMS @ 8 Ohm.

5. POLARITY

Phase of the signal can be inverted with the polarity button.

When the button is active (blue), the phase is inverted.

6. COMPRESSOR

Click on the green "COMPRESSOR" button, to display the integrated multiband compressor control window.

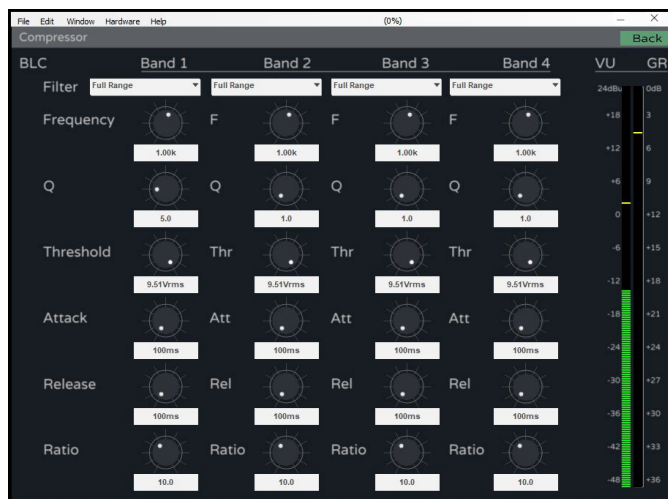

This compressor **includes 4 bands, and each band can be configured as follows:**



HW
Ctrl.
SW

HADA DSP MANAGER &
Updates

PRECAUTIONS

WARRANTY &
ENVIRONMENT

First Steps
Automatic
Connection with PC

PACKAGE
CONTENTS

DESCRIPTION &
FEATURES

Login
Main Screen

PANEL FUNCTIONS

Device
Configuration

Admin Mode

INSTALL & CONNECT

Groups

START-UP & OPERATION

TELNET Control

TECHNICAL DATA

It can operate at different frequency, bandwidth, threshold and with adjustable reaction times. It shows the input signal level and the amount of gain reduction when the compressor is running.

To close the compressor configuration window and return to the programming window, press the green highlighted “Back” button to the right of Compressor.

7. GAIN

The Gain fader acts on the gain of the input channel before the matrix mixer and is a replica of the input fader on the Main screen as well as the mute button.

If the user does not set any limiter on the output, the scale shall be referenced to the level of the output limiter or the internal limiter (maximum power).

9.7 Admin Mode

This section details the advanced functions that the installer will need to start-up the amplifier, such as:

- Output mode (Low Impedance, Low and High Impedance in Bridge Mode).
- Network configuration.
- Auto standby configuration.
- Boot-Up Mode.
- User Rights management.
- Firmware update.

For further details on each of these functions, please see the following chapters.

HW	Ctrl. SW	HADA DSP MANAGER & Updates	First Steps	Automatic Connection with PC	Login	Main Screen	Device Configuration	Admin Mode	Groups	TELNET Control	TECHNICAL DATA
		PRECAUTIONS	WARRANTY & ENVIRONMENT	PACKAGE CONTENTS	DESCRIPTION & FEATURES	PANEL FUNCTIONS	INSTALL & CONNECT	START-UP & OPERATION			

9.7.1 Output Mode

It allows you to choose whether the amplifier will work with 4 channels or, if required, it will be possible to configure the first and/or the second channel pair in bridge mode.



1. Dual Mode

Each channel pair is configured in dual mode by default. This means that each of the 4 channels will work in low impedance.

By default, the internal limiters of the amplifier are configured for a load of 4 Ohms. The amplifier module will work correctly with this output load impedance and the limiter will act when the output level is too high.

In case you need to use loads other than 4 Ohm, it is necessary to select the type of load to be used through the routing buttons section above the output faders in the **Main** menu. In this way, the internal maximum power limiters will be adjusted automatically.



HW
Ctrl.
SW

PRECAUTIONS
HADA DSP MANAGER &
Updates

WARRANTY &
ENVIRONMENT
First Steps

PACKAGE
CONTENTS
Automatic
Connection with PC

DESCRIPTION &
FEATURES
Login

PANEL FUNCTIONS
Main Screen

Device
Configuration

Admin Mode
INSTALL & CONNECT

Groups
START-UP & OPERATION

TECHNICAL DATA

TELNET Control

TECHNICAL DATA

2. Modo Bridge

With Bridge mode it is possible to get the sum of the power of two channels in a single output, in low impedance (minimum 8 Ohm) or high impedance (70V and 100V).

In this case, as in Dual Mode, the output mode of the pair of channels to be used must be configured, through the routing buttons section located above the output faders in the Main menu.



Once the amplifier is configured in bridge mode, the speaker or speaker line must be connected correctly, [as described in the Bridge Mode and Hi-Z Mode chapter](#).

When a channel pair is configured in bridge mode, input channels 1 and 3 will act as the source and output faders 1 and 3 will act as the volume control for the bridged pair, as well as the output potentiometers 1 and 3 on the front of the amplifier. The inputs, output faders and potentiometers 2 and 4 will not act on the bridged outputs.



HW	Ctrl. SW	HADA DSP MANAGER & Updates	First Steps	Automatic Connection with PC	Login	Main Screen	Device Configuration	Admin Mode	Groups	TELNET Control
PRECAUTIONS	WARRANTY & ENVIRONMENT	PACKAGE CONTENTS	DESCRIPTION & FEATURES	PANEL FUNCTIONS	INSTALL & CONNECT	START-UP & OPERATION	TECHNICAL DATA			

9.7.2 Network Settings

Allows you to configure the amplifier's network interface in DHCP or static mode and to enable or disable third party control as well.



By default, the amplifier is in DHCP mode. So, to make the connection correctly, it is also necessary to configure in the same way the network interface of the computer where the HADA DSP Manager software is installed.

If you need to assign a static IP address, please type the required network parameters in the network configuration menu.

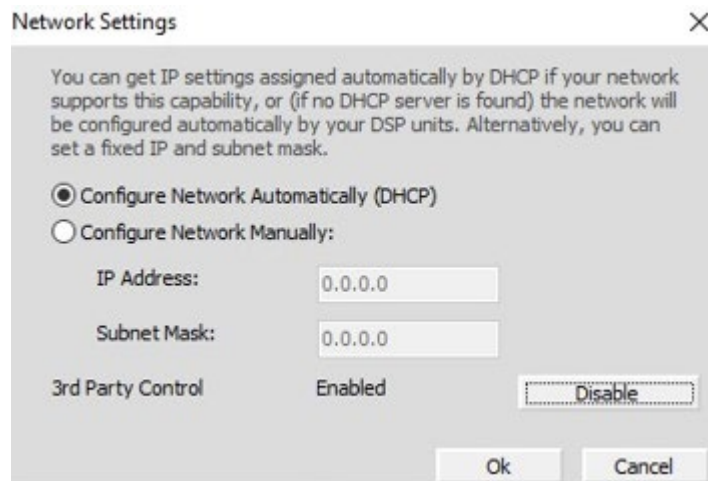

HW	Ctrl. SW	HADA DSP MANAGER & Updates	First Steps	Automatic Connection with PC	Login	Main Screen	Device Configuration	Admin Mode	Groups	TELNET Control	TECHNICAL DATA
		PRECAUTIONS	WARRANTY & ENVIRONMENT	PACKAGE CONTENTS	DESCRIPTION & FEATURES	PANEL FUNCTIONS	INSTALL & CONNECT	START-UP & OPERATION			

9.7.3 Auto Standby

Allows you to configure the automatic standby if no signal is detected at the inputs.



The delay time before the unit goes to standby when no signal is present can be set in minutes or fractions of minutes e.g. 0,5.

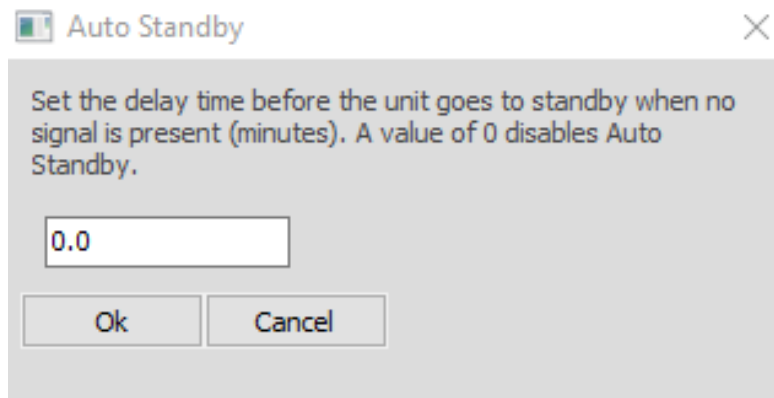

HW	Ctrl. SW	HADA DSP MANAGER & Updates	First Steps	Automatic Connection with PC	Login	Main Screen	Device Configuration	Admin Mode	Groups	TELNET Control	TECHNICAL DATA
		PRECAUTIONS	WARRANTY & ENVIRONMENT	PACKAGE CONTENTS	DESCRIPTION & FEATURES	PANEL FUNCTIONS	INSTALL & CONNECT	START-UP & OPERATION			

9.7.4 Boot-Up Mode

1. Boot-Up Mode

Allows you to select the preset the amplifier will start up with.



By default, the selected option is Last Setting, so the unit will remember the last setting and restart with it.

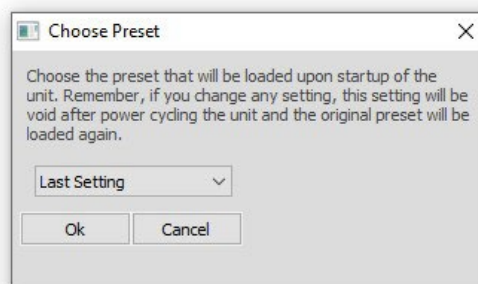

2. Preset management

In admin mode it is possible to fully manage the presets.

! In user mode, the end user can load the presets of the unit (stored in the amplifier memory) and can only choose from the presets created by the administrator. **If user tries to save a preset to the unit or to load/save a local preset, the following message will appear indicating that the user has no sufficient access rights to save presets.**

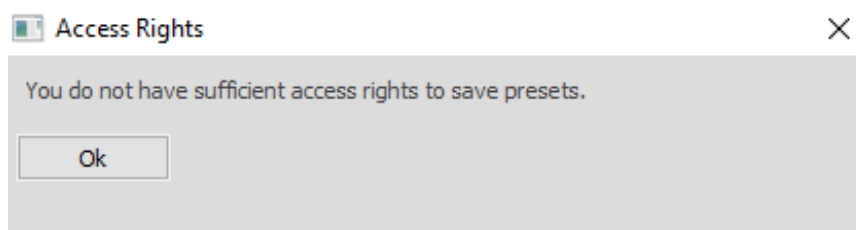

HW	Ctrl. SW	HADA DSP MANAGER & Updates	First Steps	Automatic Connection with PC	Login	Main Screen	Device Configuration	Admin Mode	Groups	TELNET Control	TECHNICAL DATA
		PRECAUTIONS	WARRANTY & ENVIRONMENT	PACKAGE CONTENTS	DESCRIPTION & FEATURES	PANEL FUNCTIONS	INSTALL & CONNECT	START-UP & OPERATION			

In admin mode, allows you to export presets (one at a time) to a local folder on the control PC by using the store buttons, as well as load presets from the PC to the amplifier with the Load button.

The Backup Presets option in the File menu, allows you to make a backup of all presets stored in the unit and later load them into other units with the Restore Presets option.

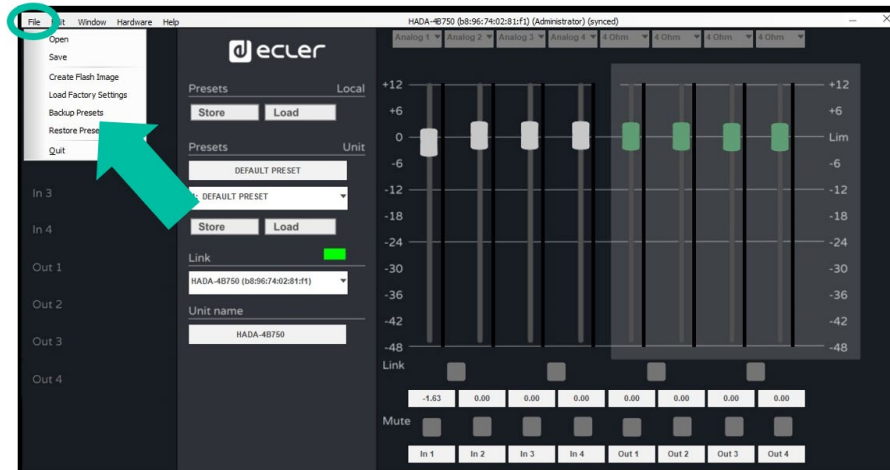

The Restore Presets option executes an automatic reset of the unit.

9.7.5 Change Access Rights for User level

In Admin mode, this option allows you to extend or limit the rights of the user mode.

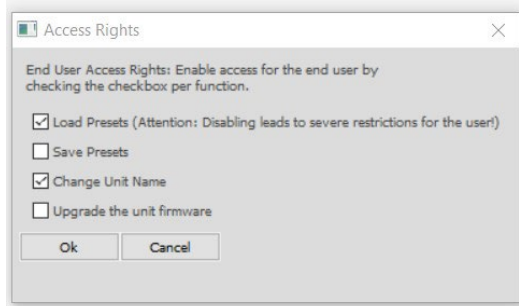
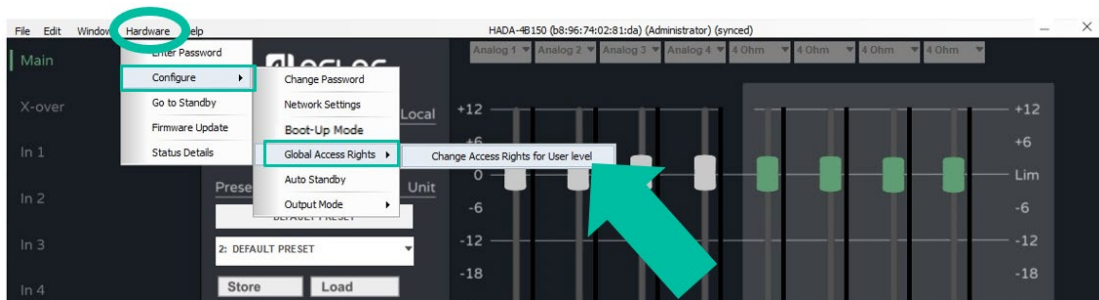

HW	Ctrl. SW	HADA DSP MANAGER & Updates	First Steps	Automatic Connection with PC	Login	Main Screen	Device Configuration	Admin Mode	Groups	TELNET Control
PRECAUTIONS	WARRANTY & ENVIRONMENT	PACKAGE CONTENTS	DESCRIPTION & FEATURES	PANEL FUNCTIONS	INSTALL & CONNECT	START-UP & OPERATION	TECHNICAL DATA			

9.7.6 Firmware Update

1. Upgrading the amplifier with the firmware included in the software.

! Each HADA DSP Manager software version includes firmware. **Updating the firmware of a HADA unit requires logging into administrator mode** unless the administrator has previously added the update right to the user.

In the configuration menu, select Hardware and click on Firmware Update.

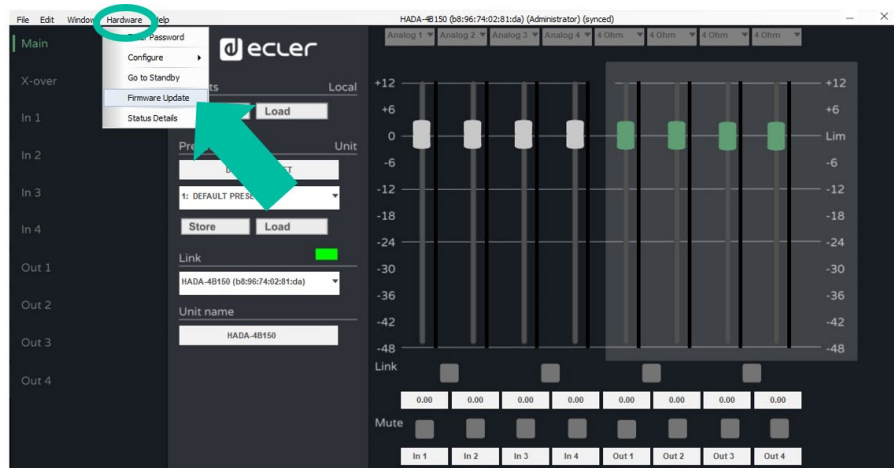

! A warning message will inform you that a **backup of the current preset is required. Otherwise, the current settings will be lost.**

! Do not switch off the device or unplug from the mains during the update process.

2. Updating all amplifiers connected to the network from the main window.

💡 If you wish to update all amplifiers connected to the network, the update can be activated from the main menu, without having to open each individual unit's configuration window.

In the main menu select Tools and click on Enable Update.



HW
Ctrl. SW

HADA DSP MANAGER &
Updates
PRECAUTIONS

WARRANTY &
ENVIRONMENT
First Steps

PACKAGE
CONTENTS
Automatic
Connection with PC

DESCRIPTION &
FEATURES
Login

PANEL FUNCTIONS
Main Screen

Device
Configuration

Admin Mode
INSTALL & CONNECT

Groups
START-UP & OPERATION
TECHNICAL DATA
TELNET Control

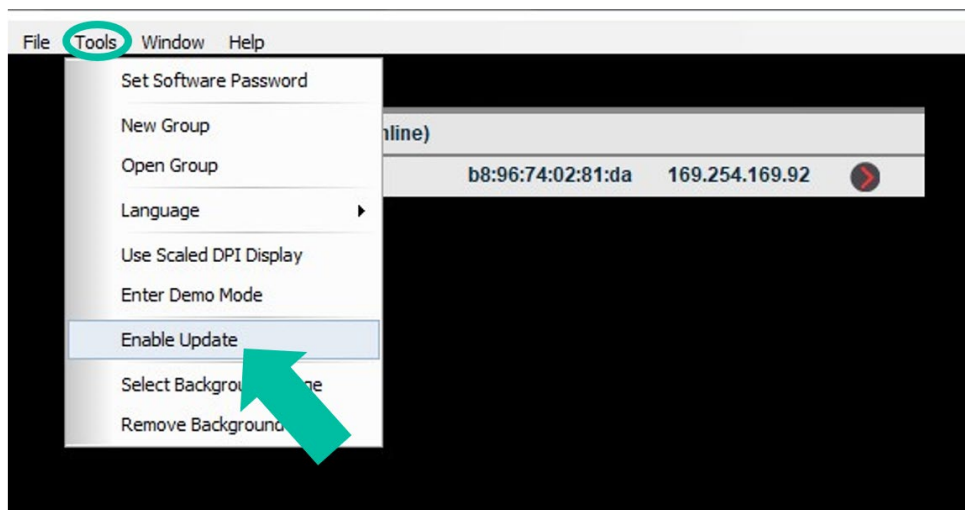

By entering the admin mode password, the update button next to each unit discovered on the network, will be activated in orange colour. Then press this button and the process to update the firmware will be the same as indicated in the previous paragraph.

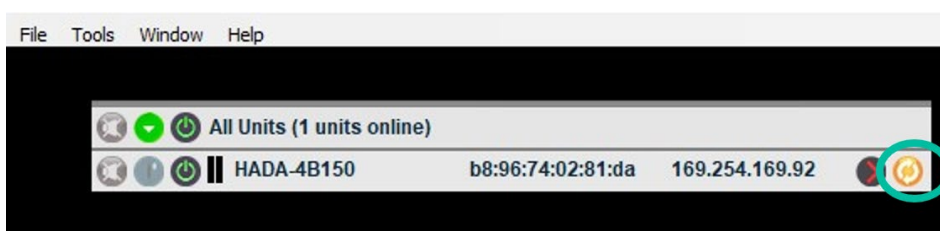

HW	Ctrl. SW	HADA DSP MANAGER & Updates	First Steps	Automatic Connection with PC	Login	Main Screen	Device Configuration	Admin Mode	Groups	TELNET Control	TECHNICAL DATA
PRECAUTIONS	WARRANTY & ENVIRONMENT	PACKAGE CONTENTS	DESCRIPTION & FEATURES	PANEL FUNCTIONS	INSTALL & CONNECT	START-UP & OPERATION					

9.7.7 Create Flash Image

Allows you to create a clone of the unit, concerning configuration, presets, and firmware.

Available in admin mode only.

In the configuration menu, select File and click on Create Flash Image to save the desired configuration locally on the control PC.

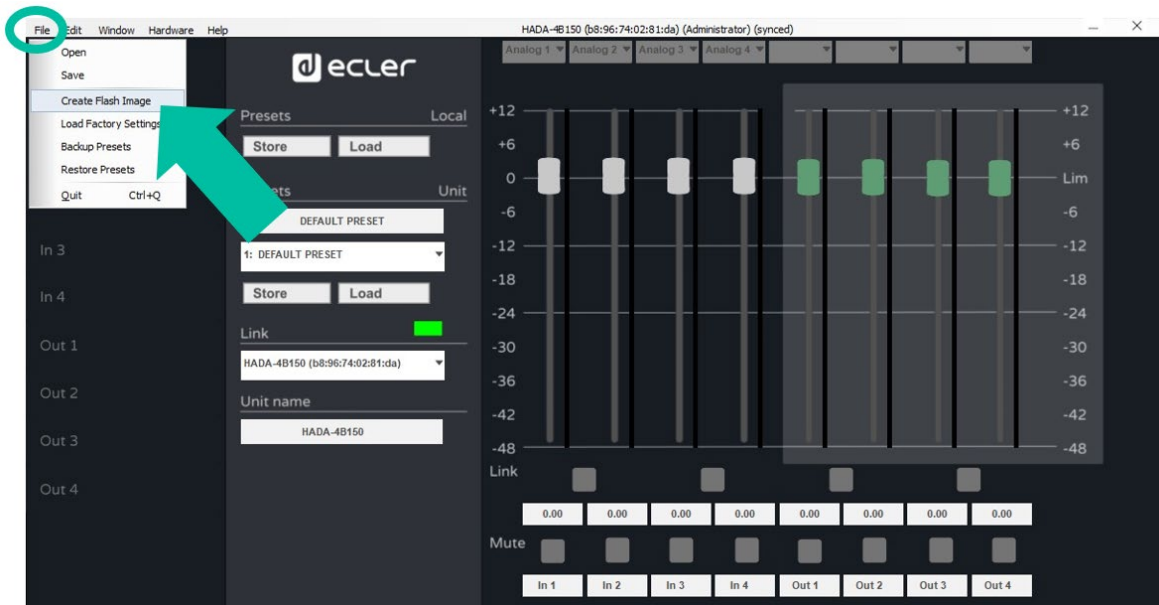

By the Load Factory Settings feature, the previously saved configuration can be loaded into another unit.

Please, always observe the correspondence of the amplifier models. Loading a picture of a model which does not correspond to the connected model can damage the device and the loudspeaker as well.



HW
Ctrl.
SW

HADA DSP MANAGER &
Updates

PRECAUTIONS

WARRANTY &
ENVIRONMENT

First Steps

Automatic
Connection with PC

PACKAGE
CONTENTS

DESCRIPTION &
FEATURES

Login

Main Screen

PANEL FUNCTIONS

Device
Configuration

Admin Mode

Groups

TELNET Control

INSTALL & CONNECT

START-UP & OPERATION

TECHNICAL DATA

9.8 Groups

It allows that several amplifiers can be controlled through the same control page.

To create a group, from the main screen, select Tools and click on New Group.

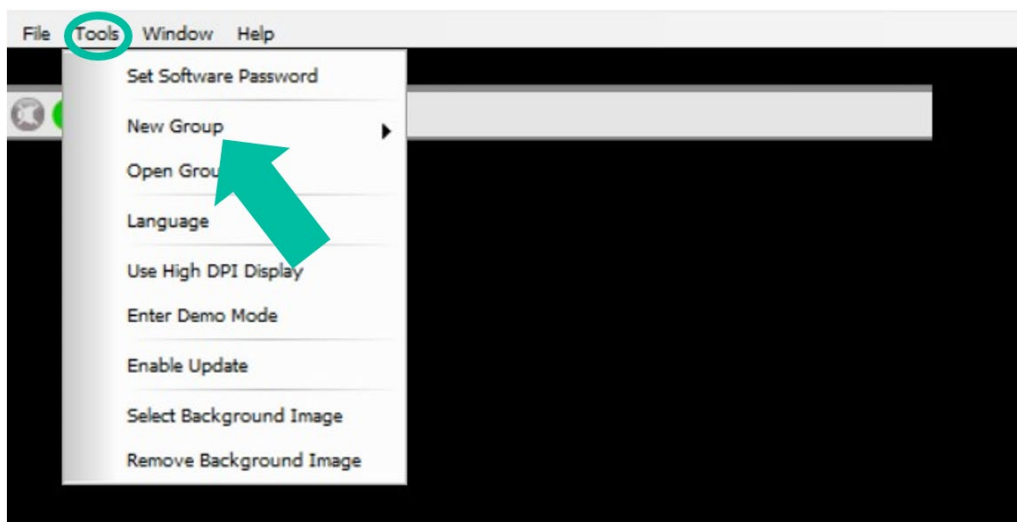

You must then assign a name to each group you create.

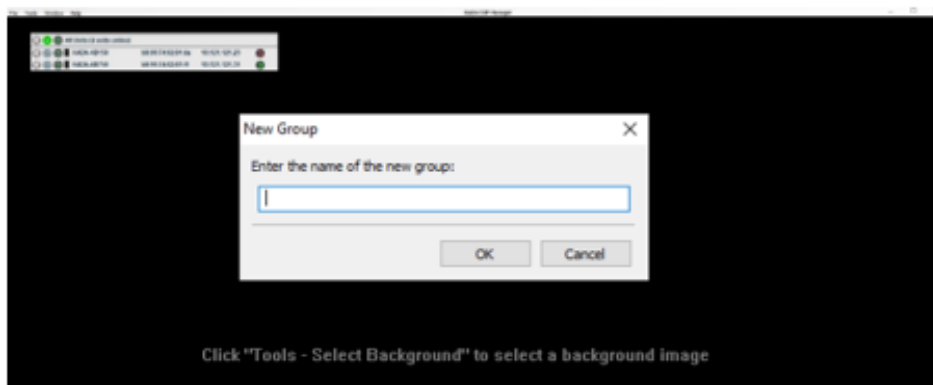

Once the group is created, click on  to determine the units that are members of the group and the functions to be grouped.



HW	Ctrl. SW	HADA DSP MANAGER & Updates	First Steps	Automatic Connection with PC	Login	Main Screen	Device Configuration	Admin Mode	Groups	TELNET Control
PRECAUTIONS	WARRANTY & ENVIRONMENT	PACKAGE CONTENTS	DESCRIPTION & FEATURES	PANEL FUNCTIONS	INSTALL & CONNECT	START-UP & OPERATION	TECHNICAL DATA			

Select the type of control:

- **Carbon Copy:** will allow multiple units to be controlled from a single configuration window.
- **Mute:** will allow control of channel mutes only.

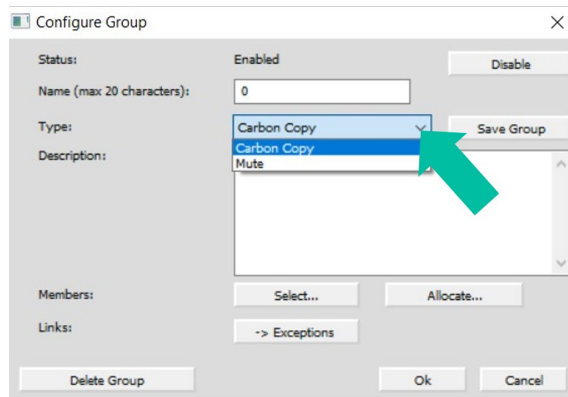

Press Select to add more units to the same group.

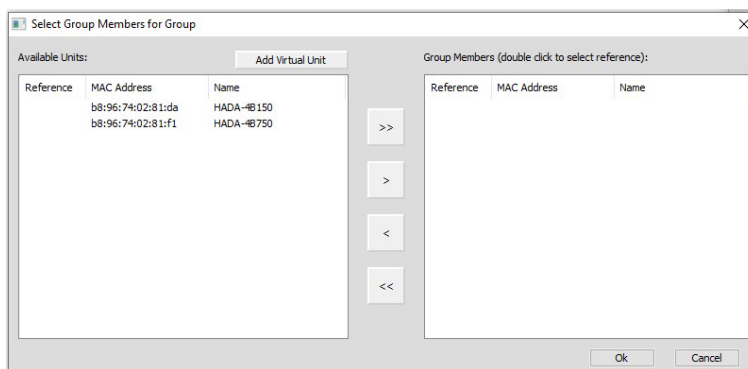
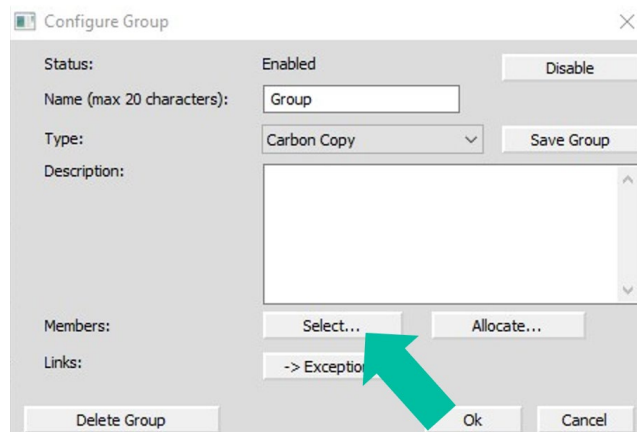

It is possible to add physical units present on the network, or virtual units to create a group without physical units to add them later.

10. TELNET CONTROL

HADA amplifiers can be controlled by Third-party control systems via Telnet protocol.

It is just necessary to use a TCP/IP client terminal by connecting to the IP address of the amplifier on port 23 to send the desired control commands.

Commands available are as follows:

- **4 inputs' volume control**

Character String: `c0i0m1n1v600e<cr><lf>`
`c0 a c3 = IN1 a IN4`

Right after the character "v" indicate the absolute value of the volume with two decimals.
 E.g.: 600=6.00dB; -1200=-12.00dB

- **4 outputs' volume control**

Character String: `c128i0m1n1v600e<cr><lf>`
`c128 a c131 = OUT1 a OUT4`

Right after the character "v" indicate the absolute value of the volume with two decimals.
 E.g.: 600=6.00dB; -1200=-12.00dB

- **Mute/Unmute**

Character String: `c0i0m2n2v1e<cr><lf>`
`c0 a c3 = IN1 a IN4`
`c128 a c131 = OUT1 a OUT4`
`v1=Mute`
`v0=Unmute`

- **Preset Recall**

Preset selection character string: `c0i0m4n4v2e<cr><lf>`
 Right after the character "v" indicate the preset number

Preset execution character string: `m3n3i1e<cr><lf>`

After executing the preset, it will be active. The graph in HADA DSP Managers (e.g. in case of volume change) will not be updated in real time but will be updated with the next connection to the software.



HW	Ctrl. SW	HADA DSP MANAGER & Updates	First Steps	Automatic Connection with PC	Login	Main Screen	Device Configuration	Admin Mode	Groups	TELNET Control	TECHNICAL DATA
		PRECAUTIONS	WARRANTY & ENVIRONMENT	PACKAGE CONTENTS	DESCRIPTION & FEATURES	PANEL FUNCTIONS	INSTALL & CONNECT	START-UP & OPERATION			



HW	SW	Ctrl.
PRECAUTIONS	WARRANTY & ENVIRONMENT	HADA DSP MANAGER & Updates
PACKAGE CONTENTS	DESCRIPTION & FEATURES	First Steps
PANEL FUNCTIONS	INSTALL & CONNECT	Automatic Connection with PC
START-UP & OPERATION	TECHNICAL DATA	Login
		Main Screen
		Device Configuration
		Admin Mode
		Groups
		TELNET Control

All product characteristics are subject to variation due to production tolerances. NEEC AUDIO BARCELONA S.L. reserves the right to make changes or improvements in the design or manufacturing that may affect these product specifications.

For technical queries contact your supplier, distributor or complete the contact form on our website, in [Support / Technical requests](#).